

# Final Design Report

## April 2023

Name of Institute: Brick School of Architecture

Team Name: Samakrut

Competition Division:

Community Resilience Structure



# TABLE OF CONTENTS

Cover Page

Table of Contents

List of Tables

List of Figures

Response to Reviewer's Comments

1.0 Executive Summary

2.0 Team Introduction

3.0 Project Background

4.0 Goals

5.0 Design Documentation

5.1 Content Map

5.2 Design Process

5.3 Macro Planning

5.4 Architectural Design

5.5 Health and Well Being

5.6 Engineering and Operations

5.7 Innovations

5.8 Water Performance

5.9 Energy Performance

5.10 Resilience

5.11 Embodied Carbon

5.12 Value Proposition

5.13 Affordability

6.0 Appendix



## LIST OF TABLES

- Table 1 - Response to reviewer's comments
- Table 2 - Multi-layered plantation planning
- Table 3 - List of species of trees
- Table 4 - Mobile Pods Calendar for 8 villages
- Table 5 - Mobile Pods Calendar for 1 village
- Table 6 - U- Value calculation of materials
- Table 7 - WWR Calculation
- Table 8 - Energy consumption table
- Table 9 - Energy generation from solar panel calculation
- Table 10 - Ventilation calculations showing air changes per hour
- Table 11 - Base case Embodied carbon estimation on design builder
- Table 12 - Proposed case Embodied carbon estimation on design builder
- Table 13 - Cost Estimation
- Table 14 - Total Project Cost



## LIST OF FIGURES

- Figure 1 - Brick School, Pune
- Figure 2 - Logo: VKe
- Figure 3 - Discussion with expert advisors
- Figure 4 - Tools used
- Figure 5 - Logo: URVEE Public Trust
- Figure 6 - News Article 1
- Figure 7 - News Article 2
- Figure 8 - News Article 3
- Figure 9 - Site
- Figure 10 - Landscape around village
- Figure 11 - Vernacular houses beneficial of climate
- Figure 12 - Failed water pipeline
- Figure 13 - Bamboo Market
- Figure 14 - Single well in the village
- Figure 15 - Bhatsa Dried River
- Figure 16 - Gram panchayat office
- Figure 17 - Existing use of wattle and daub
- Figure 18 - Content Map
- Figure 19 - Newsletters
- Figure 20 - Relative Humidity
- Figure 21 - Surface Temperature
- Figure 22 - Annual Precipitation Diagram
- Figure 23 - Wind Rose Diagram
- Figure 24 - Veluk with surrounding terrain
- Figure 25 - Section from Bhatsa River to the village settlement
- Figure 26 - Master plan
- Figure 27 - Sections
- Figure 28 - Slope analysis
- Figure 29 - Hydrology plan
- Figure 30 - Zone wise planning
- Figure 31 - Planning strategies
- Figure 32 - Water harvesing strategies
- Figure 33 - Crop rotation cycle
- Figure 34 - Trees species
- Figure 35 - Domestic stepwell
- Figure 36 - Tourist stepwell 1.0
- Figure 37 - Tourist stepwell 2.0
- Figure 38 - Masterplan
- Figure 39 - Watershed plan
- Figure 40 - Site Plan
- Figure 41 - Mobile Pods parked at Community Resilience Shelter
- Figure 42 - Recreational Community Space inside CRS
- Figure 43 - Workshop/Training Space
- Figure 44 - Image showing Character of CRS
- Figure 45 - Elevation showing Material Palette
- Figure 46 - Isometric view of CRS
- Figure 47 - Plan of community space
- Figure 48 - Thermal comfort 1
- Figure 49 - Thermal comfort 2
- Figure 50 - Thermal comfort 3

Figure 51 - Cross Ventilation  
Figure 52 - Cross Ventilation 2  
Figure 53 - Bamboo Slits  
Figure 54 - CFD Simulation at 1.5m height in cut plan  
Figure 55 - CFD Simulation at 2.8m height in cut plan  
Figure 56 - CFD Simulation at in cross section  
Figure 57 - CFD Simulation in cross section  
Figure 58 - CFD Simulation showing location of cross section above  
Figure 59 - CFD Simulation showing location of cross section above  
Figure 60 - Section  
Figure 61 - Section  
Figure 62 - Detail  
Figure 63 - Detail  
Figure 64 - Foundation Plan  
Figure 65 - Detail  
Figure 66 - Services on Macro level planning design  
Figure 67 - Water Supply and Drainage Layout  
Figure 68 - Electrical Layout  
Figure 69 - Villages  
Figure 70 - Map of connecting villages  
Figure 71 - Mobile pods  
Figure 72 - Bamboo furniture  
Figure 73 - Structural grid  
Figure 74 - Structural formwork  
Figure 75 - Joinery Details  
Figure 76 - Energy source  
Figure 77 - Sandwich slit  
Figure 78 - Section  
Figure 79 - Water filtration  
Figure 80 - Water purification supply system  
Figure 81 - Water Cycle for Micro Planning  
Figure 82 - Water Cycle for Macro Planning  
Figure 83 - Water Demand Reduction Graph  
Figure 84 - Storm water management  
Figure 85 - Chaukas  
Figure 86 - Ultra low fixtures  
Figure 87 - Root zone treatment  
Figure 88 - Smart meter  
Figure 89 - Smart meter  
Figure 90 - Wall sections  
Figure 91 - Windows design elevation  
Figure 92 - Energy consumption graph  
Figure 93 - Circuit diagram for solar trackers  
Figure 94 - system of solar trackers panels  
Figure 95 - Energy generation per day graph  
Figure 96 - Base case  
Figure 97 - Proposed case  
Figure 98 - Legend  
Figure 99 - Base case  
Figure 100- Proposed case



- Figure 101 - Legend
- Figure 102 - Comfort hours NOT MET
- Figure 103 - Ventilation calculations showing air changes per hour
- Figure 104 - Comfort hours NOT MET
- Figure 105 - Thermal comfort simulation graph
- Figure 106 - Thermal comfort simulation graph
- Figure 107 - Potential risk
- Figure 108 - Water map
- Figure 109 - Food security
- Figure 110 - Mobile pods
- Figure 111 - Reed bed
- Figure 112 - Embodied carbon graphs
- Figure 113 - Government policies
- Figure 114 - SmartPhone Application to be used for Pod tracking, Businesses, and Vocational training courses
- Figure 115 - Construction Manuals for Mobile Pods and Community Resilience Shelter
- Figure 116 - Plan
- Figure 117 - Basalt Rock
- Figure 118 - Bamboo
- Figure 119 - Wattle and Daub
- Figure 120 - Proposed bamboo farming



# REVIEWERS' COMMENTS

Section	Reviewer's Comments	Our Response
<b>Reviewer 1</b>		
<b>Energy Performance</b>	Expected electrical load details are missing	Electrical loads and percentage reduction in energy demand added in this section
<b>Water Performance</b>	A lot of work has been done in this area to provide and conserve water in this drought prone village	Details of water requirement, water procurement, and water recycling has been added in the appendix
<b>Embodied Carbon</b>	Use of locally and naturally available material is contributing to a significantly lower carbon footprint	Embodied Carbon calculations have been taken from Design Builder rather than the provided Carbon Tool due to lack of material source information
<b>Resilient Design</b>	Multi pronged approach to increasing resiliency is good	Resilience section now has a list of businesses which will prop up the economy of the village
<b>Engineering and Operations</b>	Low on engineering details of electrical and cooling systems, but for the type of building it is acceptable	We have added basic electrical and plumbing layouts in this section as well as in the appendix. This has been done keeping in mind the scale of the building and therefore are tentative.
<b>Architectural Design</b>	The design concept and materials used are well suited for the project	Greenhouse and seed banks are added. This forms a part of economic generation aspect of the project
<b>Affordability</b>	Interest costs very high % of the project cost. Effort is needed to avail low cost funds or grants to make the project affordable	Several government grants and their application has been looked into
<b>Innovation</b>	Details of mobile pods on how water treatment using solar cooker will work is sketchy.	Details added into the innovation section
<b>Health and Well Being</b>	While there are many aspects of health and well being taken up in the project, the articulation seems to be limited to thermal comfort	CFD analysis is shown in this section and also an exploded isometric view shows different strategies along with materials being used. Comfort Hours simulation is also given in energy performance section.
<b>Value Proposition</b>	Well articulated value proposition with focus on water and economic activity to create the impact	New additions of Smartphone Application and Construction Manuals have been made in Value Proposition. This section shows a glimpse of the above. We will be providing hard copies of same during the jury presentation.
<b>Reviewer 2</b>		
<b>Energy Performance</b>	Would be good to calculate the quantity of energy generated for hydro and biogas and compare it with detailed energy consumption	Energy generation through various resources have been explored and relooked into. Energy demand reduction is done through efficient fixtures and energy generation has been taken care through solar panels.
<b>Water Performance</b>	It would be useful for the team to calculate the amount of water saved through these strategies including the quantity of water that will be recycled and reused	These issues have been addressed in the water performance section
<b>Embodied Carbon</b>	Interesting (non building) strategies are used to offset carbon. A breakup of embodied carbon according to the different structures proposed would be useful	A breakup of embodied carbon has been provided with the offset.
<b>Resilient Design</b>	The response to the problems need to be quantified. Solutions need to be more nuanced so that one can quantitatively assess	All the resilience pointers have been quantified and the solutions have been worked on further
<b>Engineering and Operations</b>	Macro planning services need to be further elaborated in terms of how they work, energy consumption, energy generation. At building scale electric, plumbing and cooling services needs more detailing and quantification	All the services have now been given in detail
<b>Architectural Design</b>	Toilets provided can be rethought of taking into account the rural context and the end users	Architectural Design has been relooked into
<b>Affordability</b>	Well thought out phasing of the project to ensure savings in construction cost and usage of low cost strategies make this project attractive	Further availability of funds and breakup of project costs has been shown in cost estimation. Several government grants have been considered and a large part of the project will be done in collaboration with NGOs. Names of these NGOs with the part they play in the project has also been mentioned.
<b>Innovation</b>	Think about operators of mobile pods and their maintenance. Detailed costing of the same. Include costing of all innovations, including operation and maintenance cost and a narrative about how it will be maintained in the long run	Operation and maintenance of all innovations have been provided
<b>Health and Well Being</b>	Interesting strategies for natural cooling and passive design elements. It would help do the analysis for all the built up spaces in the proposed design	CFD analysis is shown in this section and also an exploded isometric view shows different strategies along with materials being used. Comfort Hours simulation is also given in energy performance section.

Table 1. Response to Reviewer's Comments



## 1.0 EXECUTIVE SUMMARY

Community resilience shelters are an important component of disaster preparedness and response, as they help to ensure that people have access to necessities and support services during times of crisis. Community resilience shelters are also designed to be flexible and adaptable to changing needs of the community. They can be quickly set up and expanded as needed, depending on the size and scope of the disaster. The primary goal of a community resilience shelter is to provide a safe and secure environment for people who have been displaced from their homes due to natural disasters, such as hurricanes, floods, or wildfires, or man-made disasters, such as fires, chemical spills, or terrorist attacks. These shelters provide necessities, such as food, water, and sleeping accommodations, as well as medical care and counseling services to help people cope with the trauma of their displacement.

Team Samakrut from SMEF's Brick School of Architecture and Vishwakarma Institutes, Pune is proposing the resilience shelter for a drought-prone region in Veluk located in the Thane district in Maharashtra. The design process was developed with a data-driven, integrated design approach by a multidisciplinary team from building science, architecture, and engineering disciplines along with technical support from industry partners. **The term "Community Resilience Shelter" is typically associated with a shelter that provides temporary housing for residents during natural disasters like floods. Community resilience is the potential of a group of people to withstand and recover from adverse situations. We interpret this resilience in terms of people themselves rather than natural disasters.**

Drought-prone resilience refers to the ability of individuals, communities, and ecosystems to withstand, adapt to, and recover from the impacts of drought. Drought is a prolonged period of abnormally low precipitation that can have significant impacts on agriculture, water availability, and natural resources. The project was envisioned by the group for not only drought management but to enhance the lifestyle for a better future. Our design for community resilience shelter involves a range of strategies and approaches that focus on reducing vulnerability and enhancing adaptive capacities such as Water conservation and management, Diversifying livelihoods, Enhancing soil health, Climate-resilient crop varieties, and Social safety nets. Our vision comes into being when we bifurcate the rejuvenation plan into a three-pronged approach where strategies are put in place through Macro planning, Micro planning, and a Mobile network of adaptive pods.

Designing for the village of Veluk with a population of 747 people, macro-level analysis was done with the site visit. Mapping the existing contours, hydrology study, and slope analysis were done, which resulted in to map of the potential stream to collect water and built the natural reservoir. The site with an area of 2500 sq.m. is connected by a local village road. Considering the built-up of 460 sq.m as given in the detailed area statement, the Community Resilience shelter building is designed to host 230 people at once. Thus the project will be focused on lifetime sustainable output from this proposal.

As mentioned before, the design proposal is divided into 3 parts namely; Macro planning which will host the reservoir, stepwells, and afforestation drive; Micro planning which is the actual Community Resilience Shelter; and Mobile Pods. The Macro planning holds a large reservoir near the village which will be constructed over a period of 10 to 15 years and will cater to the water requirements of the village and the Community Resilience Shelter. It will also have stepwells which are constructed uniquely according to their use. The areas surrounding these stepwells will be used for multi layered plantation which will evoke the essence of Devrai while holding shrines. Some of this vegetation will be dedicated to a concept called memory forest where people can plant trees and dedicate them to their loved ones. This part of the project is what will be the major driver of resilience of this community. It will be then supplemented by Micro planning. This holds the actual Community Resilience Shelter. It is designed keeping in mind the climate and affordability of the region. A minimal palette of materials consisting of wattle and daub, basalt, and bamboo has been selected and is procured from the site itself. Wattle and daub will be used for construction of walls; it is made out of a plant called Karvi which is readily and abundantly available in the site surroundings, and the soil will be procured from the excavation which will be done for construction of reservoir. Basalt is also used in wall construction and is procured from the same excavation done for the reservoirs. Bamboo is used for structural framing and is procured from the farming proposed in the macro plan along the green valleys (shown in the report). Before the Shelter is set up, a mobile network of pods will be deployed to cater to the basic needs of the surrounding villages. This is a part of our innovation and expresses the scalability of our design.

The EPI benchmark achieved for this Community Resilience shelter is 20.61 kWh/m<sup>2</sup>, which is a 54.75% reduction from its base case of 45.55 kWh/m<sup>2</sup> and a 62.52% reduction from its benchmark of 55 kWh/m<sup>2</sup> provided for typology of CRS. Embodied Carbon of proposed case is reduced by 67.30%. Equivalent CO<sub>2</sub> of proposed case is reduced by 59.29%. These are further offsetted by procuring materials on site itself and existing RCC structures have been retrofitted and repurposed into working spaces. Furthermore, the plantation in macro planning will act as a carbon sink in a few years. Also we have achieved an energy demand reduction of 71% from base case by using efficient lighting fixtures and it is further offsetted by 20% through energy generation by solar panels. Water demand for CRS and village is met by rainwater harvesting, stepwells and reservoir. Greywater is further recycled through a 3 stage reed bed system which offsets the water demand by 55.55% for Community Resilience Shelter as well as the village. Thus, 55% of used water is recycled and reused to achieve the sustainable goals of the design.





## 2.0 TEAM INTRODUCTION

**Team Name:** Samakrut  
**Institution Name:** SMEF's BRICK School of Architecture  
**Division:** Community Resilience Shelter

### 2.1 TEAM MEMBERS



**ATHARVA SHINDE**  
 Team Leader  
 4th year B. Arch  
 [Water Performance]



**AKSHITA SATHE**  
 Design Team  
 4th year B. Arch  
 [Water Performance]



**AANCHAL MUGDIYA**  
 Graphic Team  
 4th year B. Arch  
 [Affordability]



**ASHUTOSH GAWARE**  
 Simulation Team  
 4th year B. Arch  
 [Innovation]

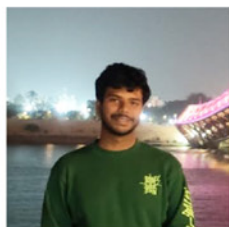

**ATHARVA VANJARI**  
 Design Team  
 4th year B. Arch  
 [Embodied Carbon]



**NEHA PATIL**  
 Simulation Team  
 4th year B. Arch  
 [Energy Performance]

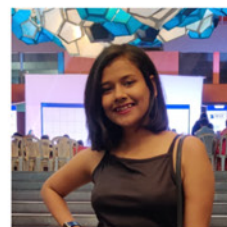

**STUTI BHAGWAT**  
 Graphic Team  
 4th year B. Arch  
 [Value Proposition]

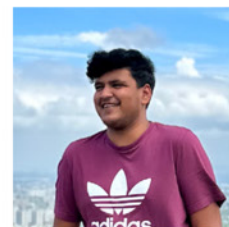

**PARTH SABLE**  
 Design Team  
 4th year B. Arch  
 [Architectural Design]

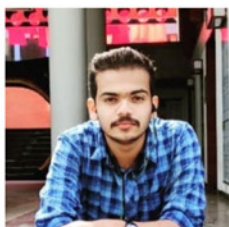

**KUNAL CHOUGULE**  
 Calculation Team  
 4th year B. Arch  
 [Resilience]



**KOMAL KONDALKAR**  
 Design Team  
 4th year B. Arch  
 [Engg. and Operations]

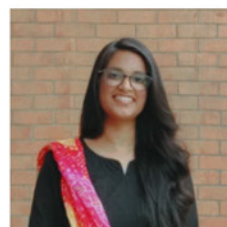

**VAISHNAVI HUNACHAGI**  
 Simulation Team  
 4th year B. Arch  
 [Health and Well Being]

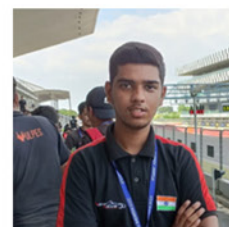

**HRUGHWED HIRVE**  
 Structural Team  
 3rd yr B.Tech Civil Engg.  
 [Communication]

### 2.2 FACULTY LEADS



**AR. VINITA LULLA**  
 Faculty Lead

Ar. Vinita has a flair for sustainable architecture, chases creativity minutely and adds aesthetics in everything she perceives.

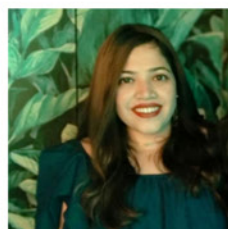

**AR. SHREYA MIRPAGAR**  
 Faculty Advisor

Ar. Shreya is creative and conscientious environmental architect passionate about design inclusive research towards sustainability.



**DR. POORVA KESKAR**  
 Faculty Advisor

Dr. Poorva is an architect and director of VKe, environment designer, quality manager, educator and author of numerous articles on the practice of environment design.



**AR. SHARWARI RAJWADE**  
 Faculty Advisor

Ar. Sharvari is a young graduate of architecture, she has deep interest towards sustainable cities and communities. As an IGBC AP, LEED GA and well AP credential holder.



## 2.3 EXPERT ADVISORS



**AR. AMRUTA NAIDU**  
 Founder and Principal  
 Architect  
 URVEE Public Trust  
 [ Project Partner ]



**AR. ALAN GEORGE JOSEPH**  
 Architect at Stapati, Calicut  
 under Ar. Tony Joseph. Worked  
 on vernacular material palette  
 and Abari-Bamboo & Earth  
 foundation in Nepal.



**AR. PRASANNA**  
 Dr. Prasanna has completed  
 his PhD in marine corrosion  
 from Nanyang Technological  
 University, Singapore. He has  
 done his Masters from UEA.



**VINAY KOLTE**  
 He has more than 20 years of  
 bamboo farming experience  
 and owns "The Bamboo  
 Nursery" in Bhor, Maharashtra.  
 The farm produces 35  
 bamboo species and native

## 2.4 LEAD INSTITUTION

At SMEF's Brick Group of Institutes, education is not limited to classrooms, textbooks, and exams. It goes beyond conventional learning and teaching techniques to encompass a global approach. The learning opportunities are endless, which students can take advantage of during extracurricular activities, research projects, or while working on social causes. This multidimensional approach to academics provides students with the necessary skills to become better designers and creators of the future.



Fig. 1. Brick School, Pune

## 2.5 INDUSTRY PARTNER

**VK:e Environmental, Pune.**

Passionately Promoting sustainability

This firm is founded by Ar. Vishwas Kulkarni. This company provides customized solutions for your project's CAPEX, OPEX, and sustainability goals through an Integrative Process. Their philosophy is to encourage business leaders to rethink their sustainability approach and take steps in that direction.



Fig. 2. Logo: VKe

## 2.6 DISCUSSIONS WITH PRAKASH BABA AMTE AND INDUSTRY PARTNER



Fig. 3. Discussion with Expert Advisor's

## 2.7 SOFTWARES

Following tools and softwares were explored and used in the design process and finalisation of project for drawing, modeling, rendering and calculations.



Fig. 4. Tools used



# 3.0 PROJECT BACKGROUND

## 3.1 INTRODUCTION

**Project Name:** EKYAM  
**Project Partner:** URVEE Public Trust  
**Key Individual:** Ar. Amruta Naidu  
**Designation:** Founder and Principal Architect



Fig. 5. URVEE Logo

URVEE Public Trust was established in November 2020 by Ar. Amruta Naidu. URVEE's work began with a vision to provide safe, eco-friendly and sustainable house construction methods to Indian villages so that villages can become self-sufficient in the construction sector. At the same time, work is done to provide hands-on experience to the budding designers guiding them in rational construction methods we practice.





## 3.2 CASE OF VELUK VILLAGE

Veluk is a village in Thane district, where the community is struggling with two major issues - drought and the practice of polygamy. Our proposed project, the Community Resilience Shelter, aims to address both of these problems while fostering economic growth and providing basic amenities to the surrounding villages at a macro level. It is a phased out project where the first step is to build a reservoir, which will provide a sustainable water source for the village. This will enable farmers to cultivate native crops and create a stable source of income for the community. The second phase is to launch a campaign to educate the villagers about the negative impacts of polygamy on their social and economic development, and provide them with alternative methods to sustain their families. To support the community's economic growth, we will establish a training center for skills and vocational training, providing workshops and retail shops to promote local businesses. This will create new employment opportunity, increase income, and help the village become self-sufficient. Finally, we will set up a mobile network of modules that will provide basic amenities to surrounding villages. This will create a well-connected network of communities, where people can access basic necessities, socialize, and exchange ideas. To summarize, our Community Resilience Shelter project offers an integrated solution to the pressing issues of drought and polygamy in Veluk. By investing in economic growth, sustainable water supply, and basic amenities for surrounding villages, we hope to create a more resilient and self-sufficient community, where everyone can thrive.

## 3.3 NEWS ARTICLES

<p><b>Water Scarcity Leads To Polygamy In This Maharashtra Village</b></p>  <p>Fig. 6. News Article 1</p> <p><b>Bhamburda:</b> Water is one of the basic essentials of life on planet earth. However, many people all over the world do not have access to clean drinking water and sometimes, even waste.</p> <p>This situation is common in drought-hit areas of India. Maharashtra is one such state in the country where several districts face drought every year.</p> <p>To deal with water crisis, one village here has come up with an unusual solution- indulging in polygamy. This means having more than one wife to procure water, termed as the 'water wives'.</p> <p>Dengannal is a small village in western Maharashtra, located some 185 km away from the capital city Mumbai. The village is situated on rocky terrain and has a population of 500. The houses here have no water pipeline connections and the area experiences drought in the hot summer months.</p> <p>The only source of water available to the villagers here is the Bibana dam on a river and a well. Both are situated so far away that, a journey to-and-fro takes nearly 12 hours. Not only is the trip arduous and long, but also time-consuming, leaving little or no time for other chores.</p>	<p><b>Global warming making India vulnerable to extreme weather events</b></p>  <p>Fig. 7. News Article 2</p> <p>India is likely to witness more extreme weather events, including intense heat waves, heavy flooding and severe drought that pose challenges to food and energy security for the second-most populous nation.</p> <p>"The extremes are increasing — hot is becoming hotter and cold is becoming colder," said M. Ravichandran, the top bureaucrat at the country's earth sciences ministry. This trend is only going to intensify every year, driven by a warming planet, he said in an interview on the sidelines of a G20 working group meeting on climate and environment in Bengaluru.</p> <p>Erratic weather conditions expose millions of Indians to climate disasters, kill thousands every year and increase economic hardships by eroding farm productivity. At the same time, it hampers the country's energy supplies by pushing demand for fossil fuels amid drying up sources of hydropower.</p> <p>Apart from extreme heat waves, India could continue to see wide variations in rainfall, with some places getting heavy downpours, while others witnessing droughts, Ravichandran said. That would mean even if the average rainfall remained normal, there could be wide variations from one region to another. There's also a possibility of the El Nino weather pattern this year, he said.</p>	<p><b>Drought-like conditions likely, Fadnavis tells Maharashtra Cabinet</b></p>  <p>Fig. 8. News Article 3</p> <p>The Indian Express has learned that Fadnavis' comment was in the context of preparing the state in terms of availability of water as well as to mitigate possible impact on agriculture due to drought.</p> <p>In a surprisingly early prediction, Maharashtra Deputy Chief Minister Devendra Fadnavis is learnt to have warned his Cabinet colleagues of the possibility of a drought-like situation in the state this year.</p> <p>At the Cabinet meeting on Tuesday, Fadnavis is learnt to have said that there were chances of an El Nino event developing in the Pacific Ocean this year, which could likely impact the monsoon rainfall.</p> <p>"There is a possibility of El Nino impact on rainfall during monsoon in Maharashtra. It is advisable to be prepared for drought-like situations in the state," he is learnt to have said at the cabinet meeting.</p>
--------------------------------------------------------------------------------------------------------------------------------------------------------------------------------------------------------------------------------------------------------------------------------------------------------------------------------------------------------------------------------------------------------------------------------------------------------------------------------------------------------------------------------------------------------------------------------------------------------------------------------------------------------------------------------------------------------------------------------------------------------------------------------------------------------------------------------------------------------------------------------------------------------------------------------------------------------------------------------------------------------------------------------------------------------------------------------------------------------------------------------------------------------------------------------------------------------------------------------------------------------------------------------------------------------------------------------------------------------------------------------	------------------------------------------------------------------------------------------------------------------------------------------------------------------------------------------------------------------------------------------------------------------------------------------------------------------------------------------------------------------------------------------------------------------------------------------------------------------------------------------------------------------------------------------------------------------------------------------------------------------------------------------------------------------------------------------------------------------------------------------------------------------------------------------------------------------------------------------------------------------------------------------------------------------------------------------------------------------------------------------------------------------------------------------------------------------------------------------------------------------------------------------------------------------------------------------------------------------------------------------------------------------------------------------------------------------------------------------------------------------------------------------------------------------------------------------------------------------------------------------------------------------------	------------------------------------------------------------------------------------------------------------------------------------------------------------------------------------------------------------------------------------------------------------------------------------------------------------------------------------------------------------------------------------------------------------------------------------------------------------------------------------------------------------------------------------------------------------------------------------------------------------------------------------------------------------------------------------------------------------------------------------------------------------------------------------------------------------------------------------------------------------------------------------------------------------------------------------------------------------------------------------------------------------------------------------------------------------------------------------

## 3.4 COMMUNITY VOICE

<p><b>Mr. Bhoir</b></p>  <p>I've been living here for 17 years and the situation hasn't changed at all. The government has attempted installing pipelines to resolve water scarcity but it is of no use. The pipelines are all dried up. Your help would mean a lot to us.</p> <p>Failure of Government Approach</p>	<p><b>Mrs. Shanti</b></p>  <p>My husband travels 40 kms everyday for work as we don't have any scope of employment nearby. It is very hectic for him to travel so much everyday at this old age. Even a small economic facility would help us a lot in our small papad business.</p> <p>No employment opportunity nearby</p>	<p><b>Mr. Vishwas</b></p>  <p>I've my own farmland in the village itself but lack of water affects the crop production to an extent that we've to be dependent on others' farms that are outside the village. Except for 2 months of monsoon, there is no water in the village.</p> <p>Affected crop production</p>	<p><b>Mrs. Janabai</b></p>  <p>I walk 3 kilometers every day to collect 2 matkas of water, taking about 3 hours each trip under the sun. Despite the exhaustion, I have to repeat this several times a day for my family's survival.</p> <p>Health Issues</p>
---------------------------------------------------------------------------------------------------------------------------------------------------------------------------------------------------------------------------------------------------------------------------------------------------------------------------------------------------------------------------------------------------------	-----------------------------------------------------------------------------------------------------------------------------------------------------------------------------------------------------------------------------------------------------------------------------------------------------------------------------------------------------------------------------------------------------------------	----------------------------------------------------------------------------------------------------------------------------------------------------------------------------------------------------------------------------------------------------------------------------------------------------------------------------------------------------------------------------------------------------------	----------------------------------------------------------------------------------------------------------------------------------------------------------------------------------------------------------------------------------------------------------------------------------------------------------------------------------------------------



### 3.5 SITE

**Project Typology:** Community Resilience Shelter  
**Location:** Veluk, Shahapur Taluka, Thane District, Maharashtra  
**Altitude:** 254m  
**Site area:** 2200 sq.m.  
**Permissible built-up area:** 2200 sq.m. (FSI = 1)  
**Permissible ground coverage:** 60%  
**Estimated built-up area:** 460 sq.m.  
**No. of floors:** G+1  
**Operation hours:** 14 hours  
**Climatic Zone:** Warm and Humid  
**Nearest Water Reservoir:** Bhatsa Reservoir  
**Purpose:** Build-own-operate  
**Stage of Project:** Unbuilt  
**Profile of occupants:** Locals, Artisans, Tourists, NGO workers



Fig. 9. Site

### 3.6 SITE DOCUMENTATION



Fig. 10. Landscape around Village



Fig. 11. Vernacular houses beneficial of climate



Fig. 12. Failed water pipeline



Fig. 13. Bamboo Market



Fig. 14. Single well in the village



Fig. 15. Bhatsa - Dried river



Fig. 16. Grampanchayat office



Fig. 17. Existing use of Wattle and daub

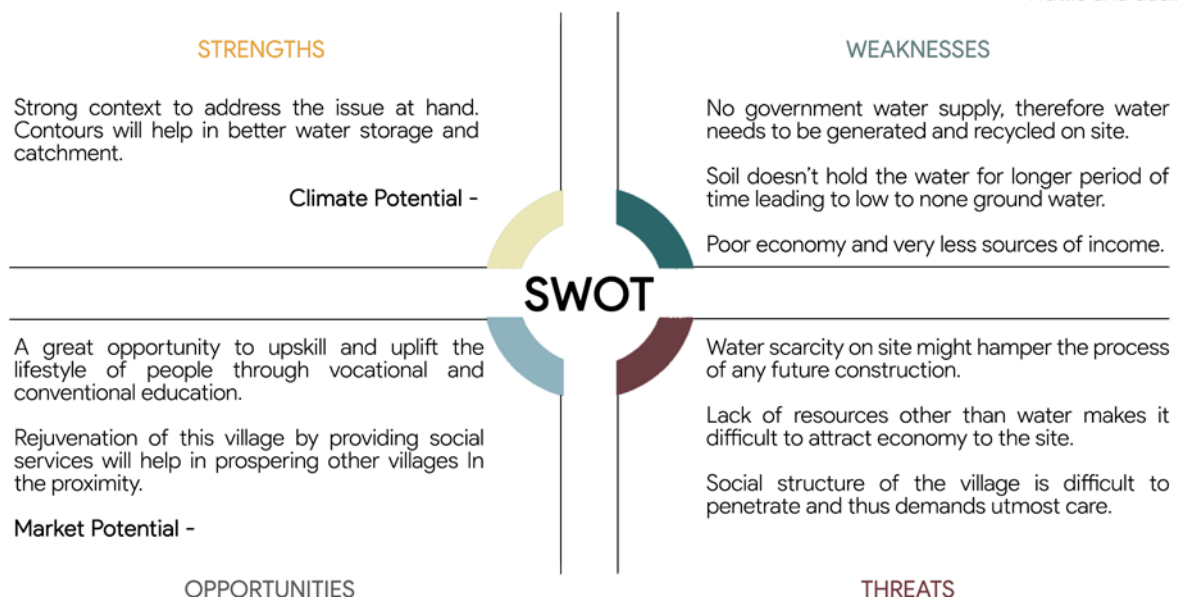

## 4.0 GOALS

### 4.1 PRIMARY GOALS

#### Water Performance

60% Water savings, 30,000,000 L water reservoir for human consumption through strategies like water efficient plumbing fixtures, dual plumbing system, water metering, drip irrigation (bamboo shoots), bioswales, terraced trenches, surangam(catchment sumps), Panam Keni, zabo, crop rotation, etc.



#### Resilience

Job employment for 350+ people (70% of the total population), through resilient to withstand droughts and calamities and creating job appotunies in the CRS.



#### Energy Performance

Target EPI of 55, energy savings of 50% through integration of passive design strategies, reduce heat gain, solar panels, peloton wheel energy generation, building orientation, fenestration design, lighting, plug loads, cooling loads.



#### Architectural Design

Modular design, community gathering spaces, cultural hub, thermally comfortable environment, spatial planning according to orientation, vegetative shading, cluster planning, and daylight potential to achieve a minimum of 90% of the area throughout the year.



#### Affordability

Cradle-to-cradle systems; local materials (bamboo, wood), reduced construction and maintenance cost, modular design and flexibility over large scale. Material specifications, modular construction, local labour, self-sustainable.



### 4.2 SECONDARY GOALS

#### Social Stability

Cultural hub, community gathering space, employment generation for men and women in fields, construction, networking with



#### Innovation

To innovate on-site water generation sector to offset the water demand, peloton wheel, water filtration, water collection system (an amalgamation of traditional methods and local material), water filtration through canals(macro and micro level) used.



#### Value proposition

Phase-wise design to cater to user needs, strategies like modular design, flexible modules, expandable design as a future provision. Rejuvenation of village through employed design strategies.



#### Health and well-being

Ensuring indoor environmental quality (indoor air quality, natural paints) by using mud as a material, air purifying plants, and shaded pathways with climbers over bamboo shade to maintain indoor environmental quality.



### 4.3 TERTIARY GOALS

#### Communication

Collaborate with NGOs to increase awareness of water conservation and efficient agriculture practices. Focus on afforestation and conduct learning and teaching seminars to address the current situation.



#### Engineering and Operations

Minimize material waste and energy consumption during construction & operation.



#### Embodied Carbon

Reducing embodied carbon as much as possible by using local materials for construction. Cutting transportation costs. Innovations in material design and use to reduce cooling loads and efficiently reduce waste.



# 5.0 DESIGN DOCUMENTATION

## 5.1 CONTENT

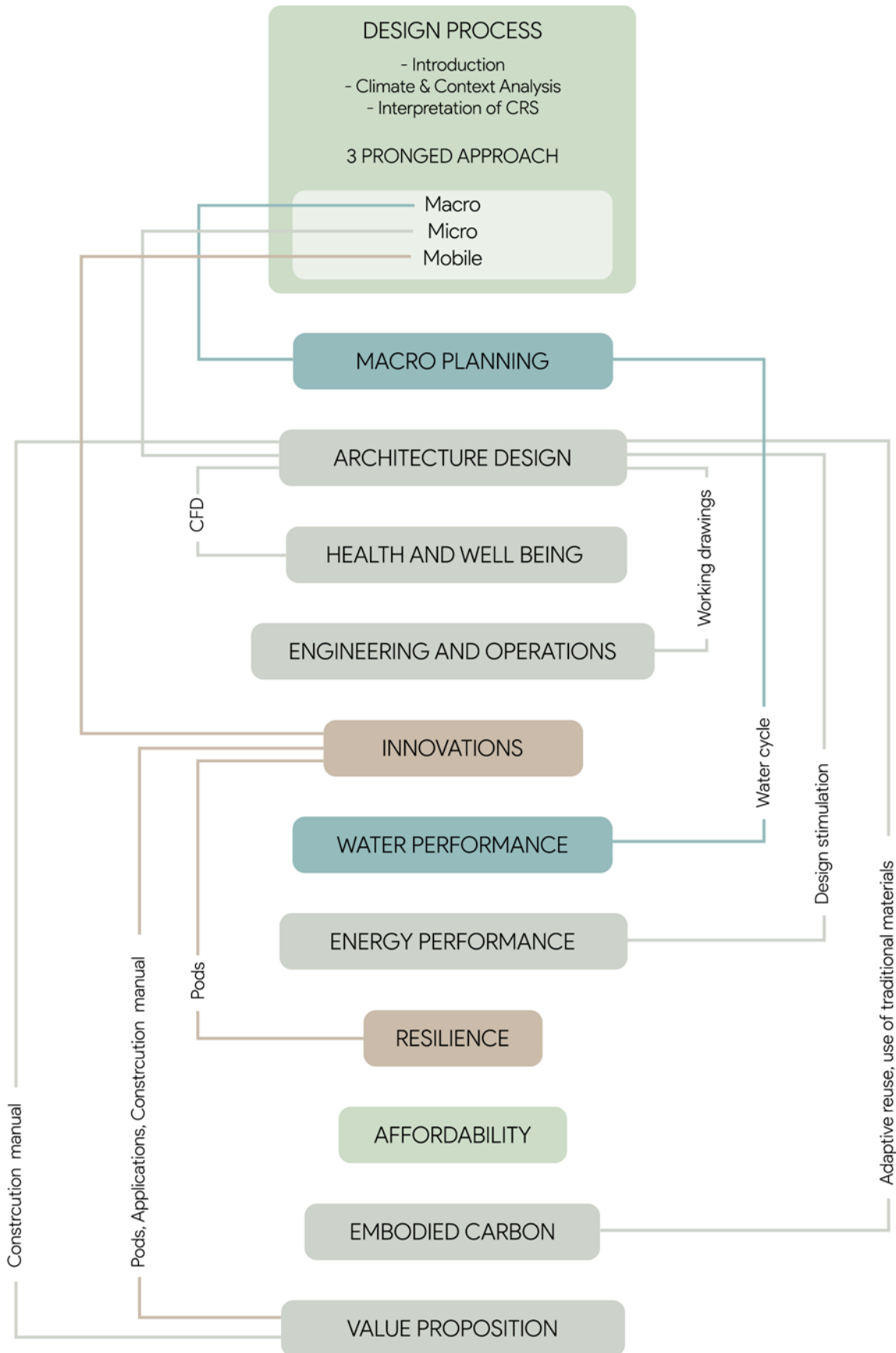

Fig. 18. Content Map



## 5.2 DESIGN PROCESS

Veluk faces drought and polygamy issues. Despite receiving 600-700 mm of rainfall during monsoons, the rocky terrain prevents water from seeping into underground reservoirs, resulting in a shortage of water outside the monsoon season. To address the water scarcity issue, they practice polygamy, where men have multiple wives. The women devote a significant portion of their day to collect water, while the men often work in nearby industries.

We followed the process below to solve these issues and rejuvenate the village over a period of time.



Fig. 19. Newsletters

### 5.2.1 CLIMATE ANALYSIS

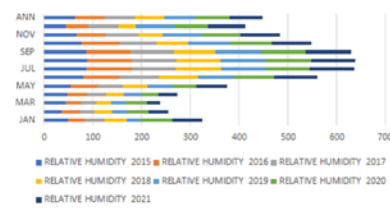

Fig. 20. Relative Humidity

(Source of climate data : QGIS Software)

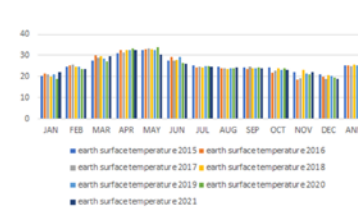

Fig. 21. Surface Temperature

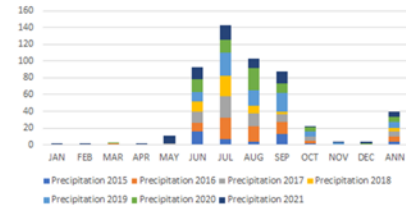

Fig. 22. Annual Precipitation Data

The region experiences a hot and dry climate with temperatures ranging from 13°C to 40°C. The average temperature is 27°C, and high humidity is observed during monsoon months (80% to 100% in August, lowest in January) while low humidity is observed during summer months (40% to 60%). The region experiences considerable rain during monsoon months, but May is prone to drought conditions due to dryness.

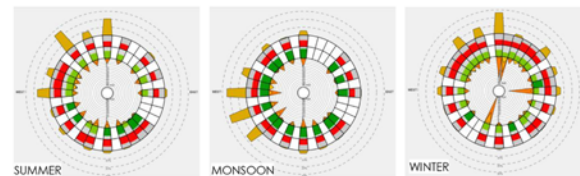

Fig. 23. Wind rose diagram

Summer winds : north-west to South-east  
 Winter winds : north- west and north-east to south  
 Monsoon winds : south - west to north - east

### 5.2.2 CONTEXT ANALYSIS



Fig. 24. Veluk with surrounding terrain

Village: VELUK  
 Grampanchayat: Veluk village  
 Block / Tehsil: Shahapur  
 District: Thane  
 State: Maharashtra  
 National Highways Reachable To Veluk:  
 - National High Way :NH61  
 - National High Way :NH160  
 Rivers Near Veluk:  
 -Bhairangi  
 -Kalu

Veluk is a small village/hamlet in Shahapur Taluka in Thane District of Maharashtra State, India. It comes under Veluk Panchayath in the Konkan region, which is a part of the Konkan Division. It is situated 81 KM east of Thane, the district headquarters, 20 KM from Shahapur, and 106 KM from Mumbai, the state capital. The village is situated on rocky terrain and has a population of 747. Igatpuri is nearest town to Veluk for all major economic activities, which is approximately 34km away.

### 5.2.3 CRS INTERPRETATION AND APPROACH

The term "Community Resilience Shelter" is typically associated with a shelter that provides temporary housing for residents during natural disasters like floods. Community resilience is the potential of a group of people to withstand and recover from adverse situations. We interpret this resilience in terms of people themselves rather than natural disasters.

Our vision comes into being when we bifurcate the rejuvenation plan into a three-pronged approach where strategies are put in place through Macro planning, Micro planning and a Mobile network of adaptive pods.



### 5.2.4. MACRO PLANNING

In Macro planning we are proposing multiple step-wells which will serve different purposes like Domestic chores, seepage of water, and water storage. Another reservoir is proposed which will cater to the water needs of the whole village and farming in the long run. These constructions are done in different phases as the rejuvenation plan advances. The first three years will be dedicated to stepwell construction and bamboo farming. These will form a base for the construction of a Community Resilience Shelter. Afforestation is proposed in the form of Devrais which are scattered throughout the landscape. The bamboo farming proposed will be given as a certain percentage of farms and will be harvested by the end of 3 years.

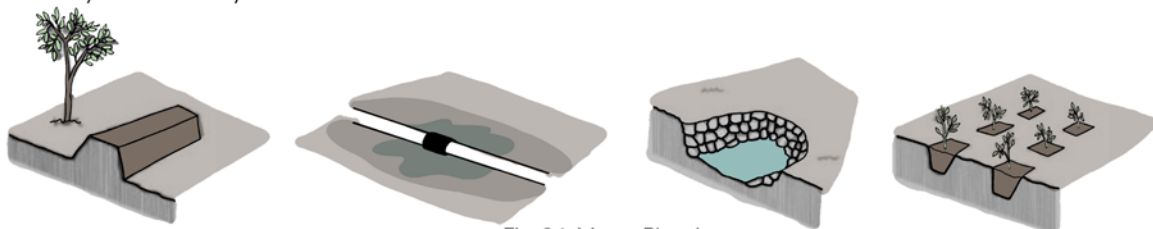

Fig. 34. Marco Planning

### 5.2.5 MICRO PLANNING

The harvested Bamboo will then be used in Micro planning where we are building the Community Resilience Shelter. There are 2 existing RCC structures on site which are repurposed as Administration spaces and a medical facility. The main structure is taken under a single roof and is constructed as an extension to the administrative space. Shops and training spaces used for community congregation are planned under this roof. A bamboo curing plant is placed at the southeast end of the site, a major economic generator for the village. Multiple community spaces are also planned and landscaped on site.



Fig. 35. Micro Planning

### 5.2.6 MOBILE NETWORK

The mobile network pods will uplift the quality of life in the village. A number of other villages in the surrounding region go through the same problems of drought and other social ailments. These problems can be catered to by providing essential services (like medical services, transportation goods, upskill,ing and vocational programs for employment) in some form.

Therefore we have created a network of 8 villages which will be connected through mobile pods. For this, a significant amount of the the footprint of Community Resilience Shelter is made mobile and now caters to about 8900 people instead of just the population of Veluk. Without this move, Community Resilience Shelter will stand as a stagnant structure but with mobility pods, we form a sustainable network of villages who go through a similar life. This will help in fostering a sustainable community of people with social awareness and community participation.



Fig. 36. Community Participation



Fig. 37. Market Potential and Scalability

### 5.2.7 PHASE WISE CONSTRUCTION TIMELINE

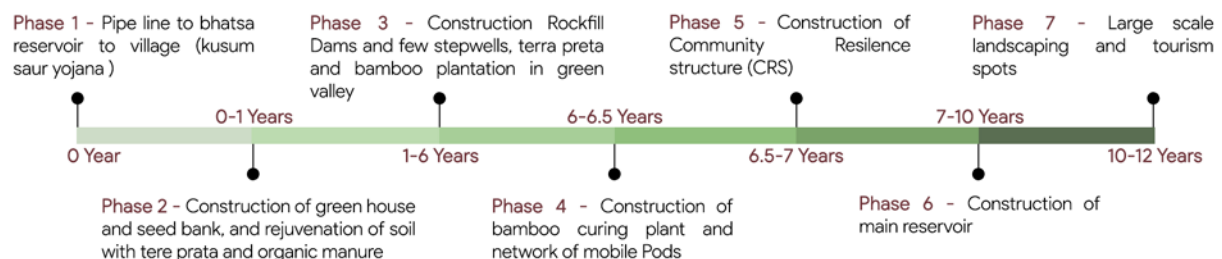

Fig. 36. Construction Timeline





### 5.3 MACRO PLANNING

#### KUSUM SOLAR YOJNA

Pradhan Mantri Kisan Urja Suraksha evam Utthan Mahabhiyaan (PM-KUSUM). With the help of this scheme the central government provides solar pumps which are operated by solar panels. This saves the fuel cost, mechanical energy and



For initial stages, to fulfill the minimal need of water requirement of the village, solar pumps are set up in a series which will pump out from the Bhatsa river. Then, the water is pumped out to the series of storage tanks which will lead to village's overhead tank.

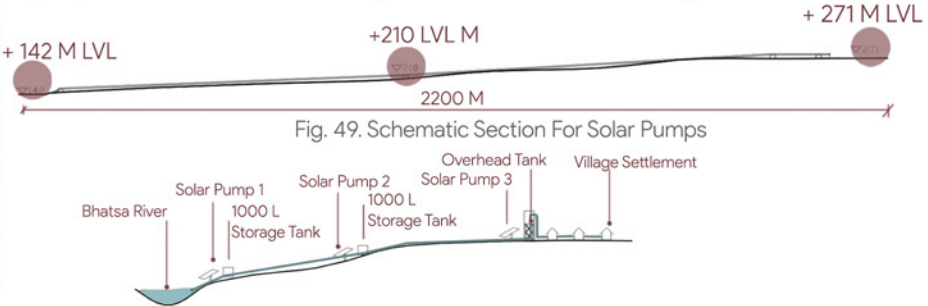
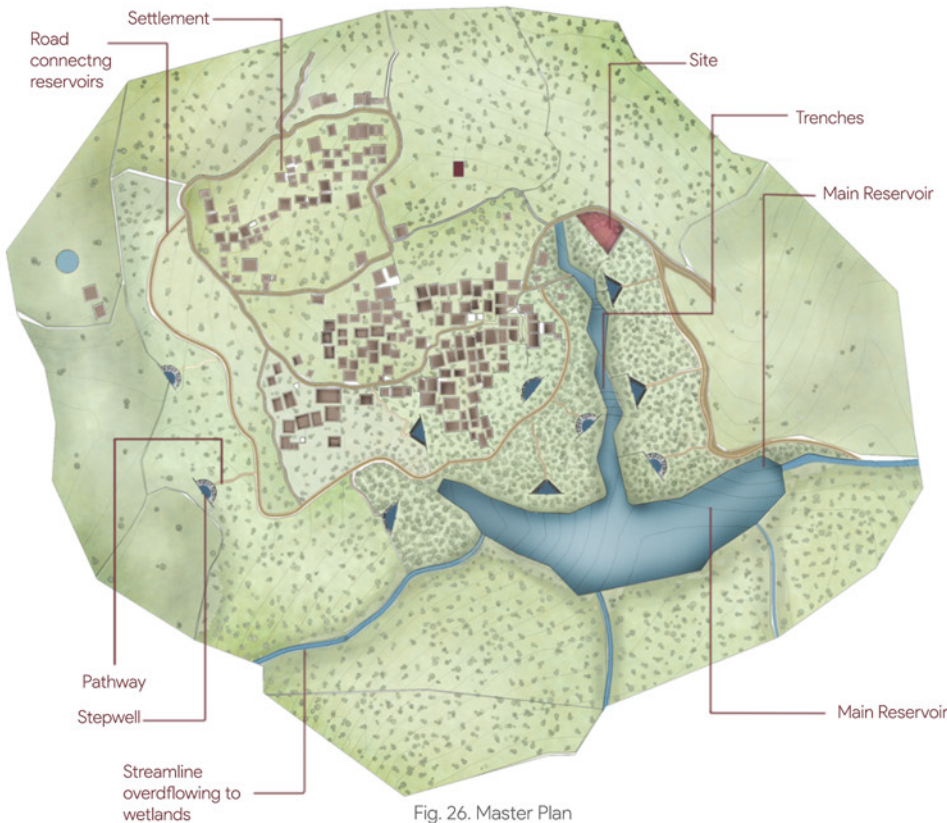

Fig. 25. Section From Bhatsa River to the village settlement



The master plan envisages 10 reservoirs to collect the runoff. The overflow of each reservoir goes eventually into a series of wetlands along the periphery of the site. It is projected that the wells outside our site will benefit from this recharge and their water levels increase. This overflow is expected to help recharge wells outside of the site and raise the water levels in those wells.

The decision to build numerous small reservoirs instead of a few large ones reflects a commitment to democracy and diversity. Since small reservoirs are easier and less expensive to construct in an earthquake-prone zone, they can be built incrementally over time. Additionally, building a reservoir promotes a stronger sense of social connectivity and a shared sense of ownership among the affected families.

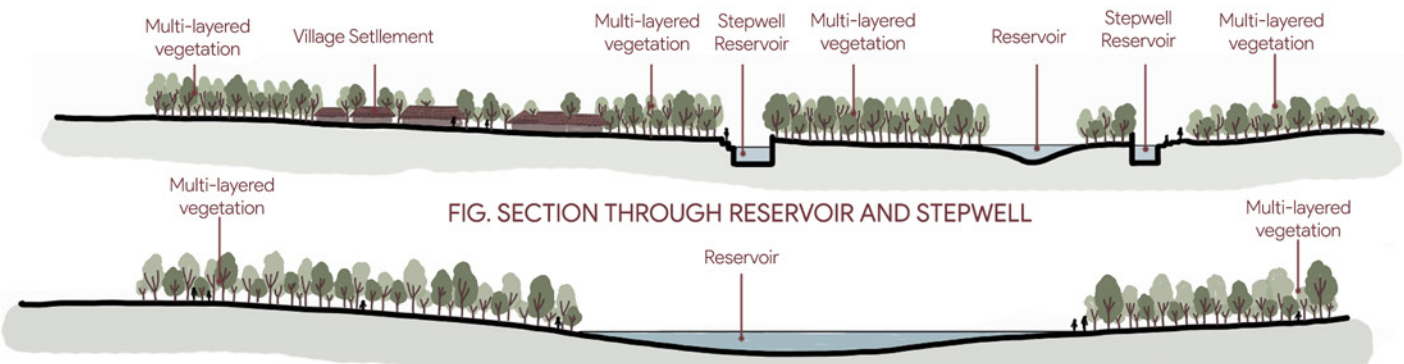

Fig. 27. Sections



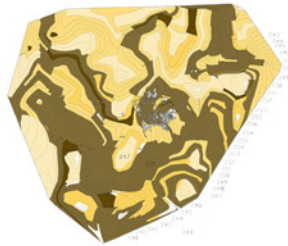

Fig. 28. Slope Analysis

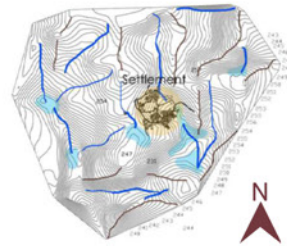

Fig. 29. Hydrology Plan

### 5.3.1 ZONE WISE PLANNING



**LEGEND**

- Domestic zone
- Tourist zone
- Seepage Zone
- Storage zone

Fig. 30. Zone-wise Planning

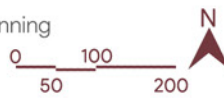

Bunds - CCTs, but generally dug at the foot of the hill. This WAT is bigger than CCT.

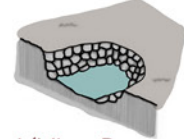

Pannam Keni (Micro Basin) - Micro basins are used in agriculture to collect surface run-off, increase water infiltration and prevent soil erosion.



Planting Pits - Planting pits are used as a precipitation harvesting method to prevent water runoff and thereby increase infiltration and reduce erosion.

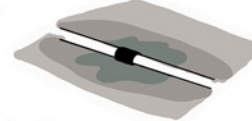

Drip Irrigation - Drip irrigation is a type of irrigation system that delivers water directly to the roots of plants through a network of tubes or hoses.



Water Absorbent Trenches - Water absorbent trenches are a type of sustainable drainage system that are designed to capture and absorb rainwater and surface runoff, and slowly release it back into the soil.



Qanats - A qanat consists of a series of underground tunnels or channels that are dug into the ground at a slight downward slope to allow water to flow from a high-elevation source



Fig. 32. Water Harvesting Strategies

RFDS - Gabion/ Rock Fill Dam is an extended structure of Loose Boulder check, with dry stone packing and wire brush. It is a stone structure constructed across the drainage, mainly in the middle reaches of active gullies, where erosion is high.

### 5.3.2 PLANNING STRATEGY



**LEGEND**

- Devrai
- Interactive landscape
- Productive landscape
- Vegetation

Fig. 31. Planning Strategy

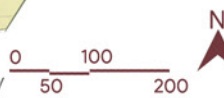

### 5.3.3 MULTI-LAYERED PLANTATION GRID

The aim of multilayered plantation is to optimize the use of available land, increase the productivity of the system, and create a sustainable and diversified agricultural system. The plantation grid is inspired from the concept of Devrais.

- Divided into square grids of 3x 3 M .
- At the centre of the land adjacent to which is a 20 x 20 ft pond of water ( can be water body like well, baoli).
- On the remaining area, a sapling is planted in each square of the grid. The same species of saplings are planted in four adjacent squares so that they grow well with each other's support.
- The drip system of irrigation is used and saplings are watered 2 3 times a week.

1 CL	2 AR	3 AH	4 MI	5 ZR		6 MK	7 TA	8 EO	9 PP	10 BM
11 CL	12 AR	13 AH	14 MI	15 ZR		16 MK	17 TA	18 EO	19 PP	20 BM
21 BM	22 PP	23 EO	24 TA	25 MK		26 ZR	27 MI	28 AH	29 AR	30 CL
31 BM	32 PP	33 EO	34 TA	35 MK		36 ZR	37 MI	38 AH	39 AR	40 CL
41 AR	42 AH	43 MI	44 ZR	45 MK		46 BM	47 TA	48 EO	49 PP	50 BM
51 AR	52 AH	53 MI	54 ZR	55 MK		56 CL	57 TA	58 EO	59 PP	60 BM
61 PP	62 EO	63 TA	64 CL	65 BM		66 AR	67 MK	68 ZR	69 MI	70 AH
71 PP	72 EO	73 TA	74 CL	75 BM		76 AR	77 MK	78 ZR	79 MI	80 AH
81 AH	82 MI	83 ZR	84 MK	85 TA		86 EO	87 PP	88 BM	89 CL	90 AR
91 AH	92 MI	93 ZR	94 MK	95 TA		96 EO	97 PP	98 BM	99 CL	100 AR

Table 2. Multi-layered plantation planning

SNO.	MARATHI NAME	SCIENTIFIC NAME	1ST HARVEST/ FULLY GROWN	ABBREVIATION	TYPE	QUANTITY	GRID NUMBER
1	Kadu Limb	A limon, Citrus limonum	2 Years	CL	Tree		
2	Ramphal	Annona Reticulata	3-5 Years	AR	Tree		
3	Phanas	Artocarpus Heterophyllus	3 Years	AH	Tree		
4	Aamba	Mango, Mangifera Indica	3-4 Years	MI	Tree		
5	Toran	Ziziphus Rugosa, Family: Rhamnaceae	2 Year	ZR	Tree		
6	Kadipatta	Murraya Koenigii, Curry tree	2 Years	MK	Tree		
7	Arjun	Terminalia Arjuna, Arjun tree	4 Years	TA	Tree		
8	Avala	Indian Gooseberry, Emblica Officinalis	3-4 Years	EO	Tree		
9	Karanj	Pongamia Pongamia pinnata	3-4 Years	PP	Tree		
10	Palas	Butea Monosperma	5 Years	BM	Tree		

Table 3. List of species of trees

### MULTI-LAYERED PLANTATION GRID

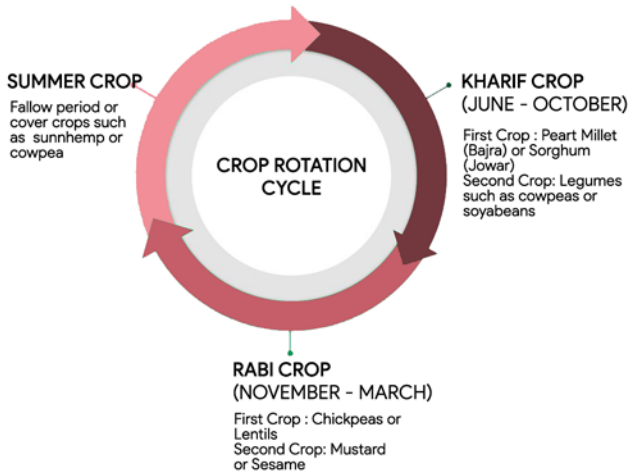

Fig. 33. Crop rotation cycle

### MULTI-LAYERED PLANTATION SPECIES



Fig. 34. Trees Species

### 5.3.4 STEPWELLS

The gabion reservoirs collect rainwater without mortar, allowing it to seep slowly into the ground for trees to use. The alluvium carried by the water fills the gaps in the stones and grows plants, making the structure blend into the landscape over time.

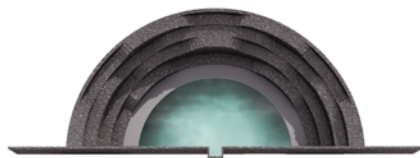

Fig. 35. Domestic Stepwell

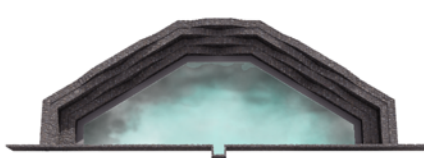

Fig. 36. Tourist Stepwell 1.0



Fig. 37. Tourist Stepwell 2.0

**Domestic well** - The circular shape allowed for a greater surface area, providing more space for people to access the water and draw it out. The well will be used for domestic purposes like washing, cleaning, cattles.

**Tourist Stepwell 1.0** - The octagonal shape creates more corners, which allows for more points of entry and exit for people drawing water. This is particularly useful when multiple people need access to the well at the same time, as it reduces congestion and waiting times.

**Tourist Stepwell 2.0** - The stepwells will be mostly used for gatherings, seating space and recreational spaces The V shape allows the stepwell to follow the contours of the land, providing a more stable foundation and reducing the risk of soil erosion and also maximizes the use of space, allowing for more water storage capacity in a smaller area.



**BAMBOO**

Species - Dendrocalamus Strictus. It grows in semi arid and arid region with relative less humidity. They survive in such extreme conditions.

Use - Making frames, rafter, poles, scaffolding.

Under area of 12 acres, 5000 bamboo saplings can be grown under well irrigation condition.

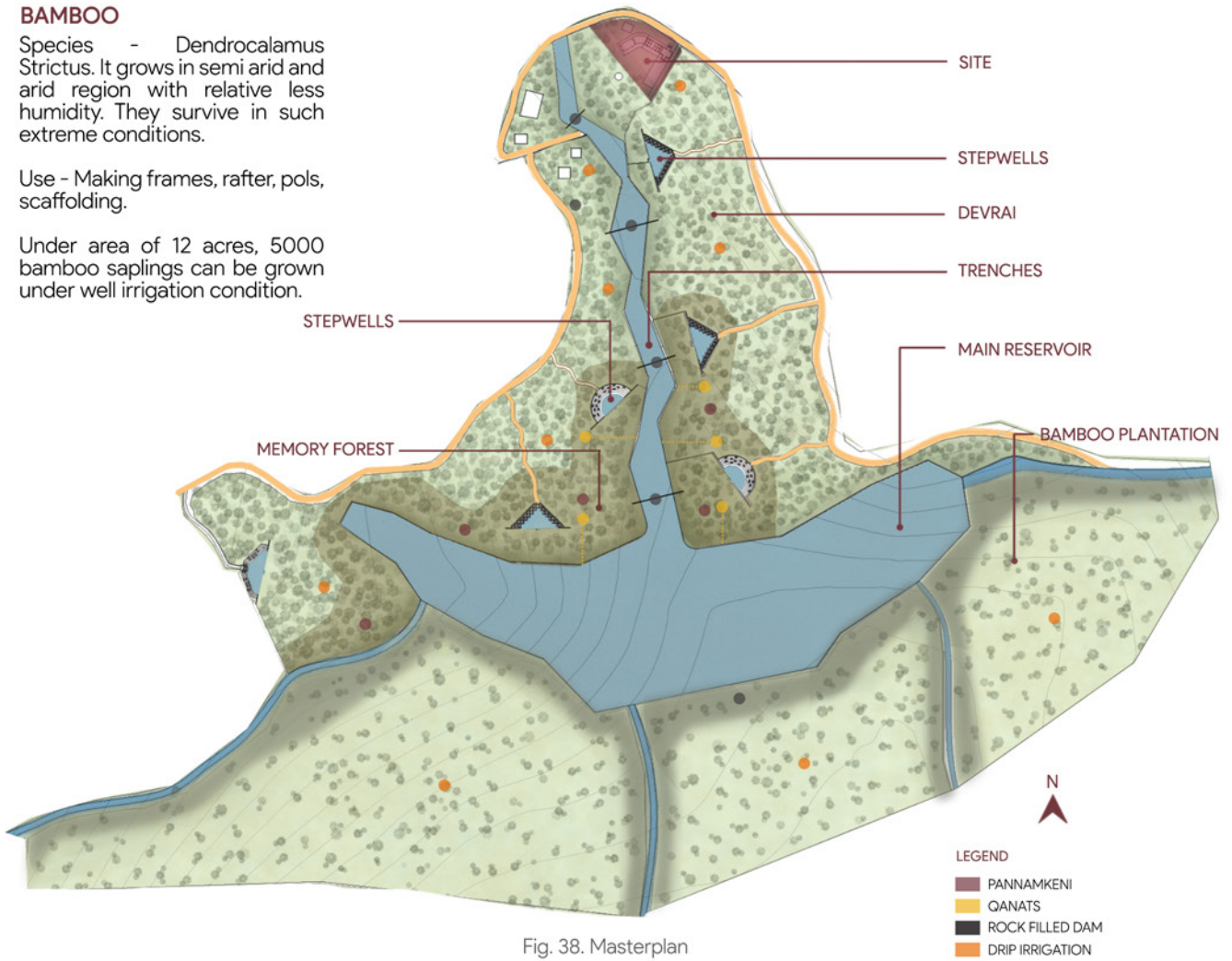

Fig. 38. Masterplan



Fig. 39. Watershed Plan

Source: <https://bhuvan-app1.nrsc.gov.in/gwis/gwis.php#>



## 5.4 ARCHITECTURAL DESIGN

Site for CRS was selected next to the water reservoir we are constructing, the site is along the prime road which connects the village with outer world.

According to needs of villagers four spaces were identified, daily shops, community space, medical facility and bamboo curing plant for creating opportunities.

The whole primary structure which comprises of community space and shops is taken under single continuous roof, which acts as extension to existing structure which is repurposed. Existing structure is repurposed for administration department. The market space has four shops and at the back side there is storage for them. The walls are made of carvi. Which is a low maintenance low price natural material.

For forming a market space four shops have been planned where different vendors can sell their goods. They are provided with storage at the back side and ramp access is given to shops for loading and unloading of goods. Larger roof overhangs are planned for these spaces which acts as buffer spaces and protects the wall materials from weathering effects. Vegetable vendors, fruit vendors, barber shop, tailor shop, agricultural products shop, grocery vendors, dairy products vendors can come and set up their shops in provided market places.

Community space is designed as a multipurpose space with different activities such as community gatherings, training activities and workshops. The space is provided with larger openings with the help of sliding folding doors, it opens up into outdoor community spaces from front side as well as the back side. On the southern facade space is provided with sandwich carvi panels for ensuring minimum heat gain. The louvres are provided above the sliding folding doors for ensuring maximum ventilation and air flow. The roof height is elevated from northern side in order to ensure the maximum diffused natural light penetration inside the spaces.



Fig. 40. Site Plan



### 5.4.1 VIEWS



Fig. 41. Mobile Pods parked at Community Resilience Shelter



Fig. 42. Recreational Community Space inside CRS



Fig. 44. Image showing Character of CRS



Fig. 43. Workshop/Training Space



Fig. 45. Elevation showing Material Palette



### 5.4.2 EXPLODED ISOMETRIC VIEW

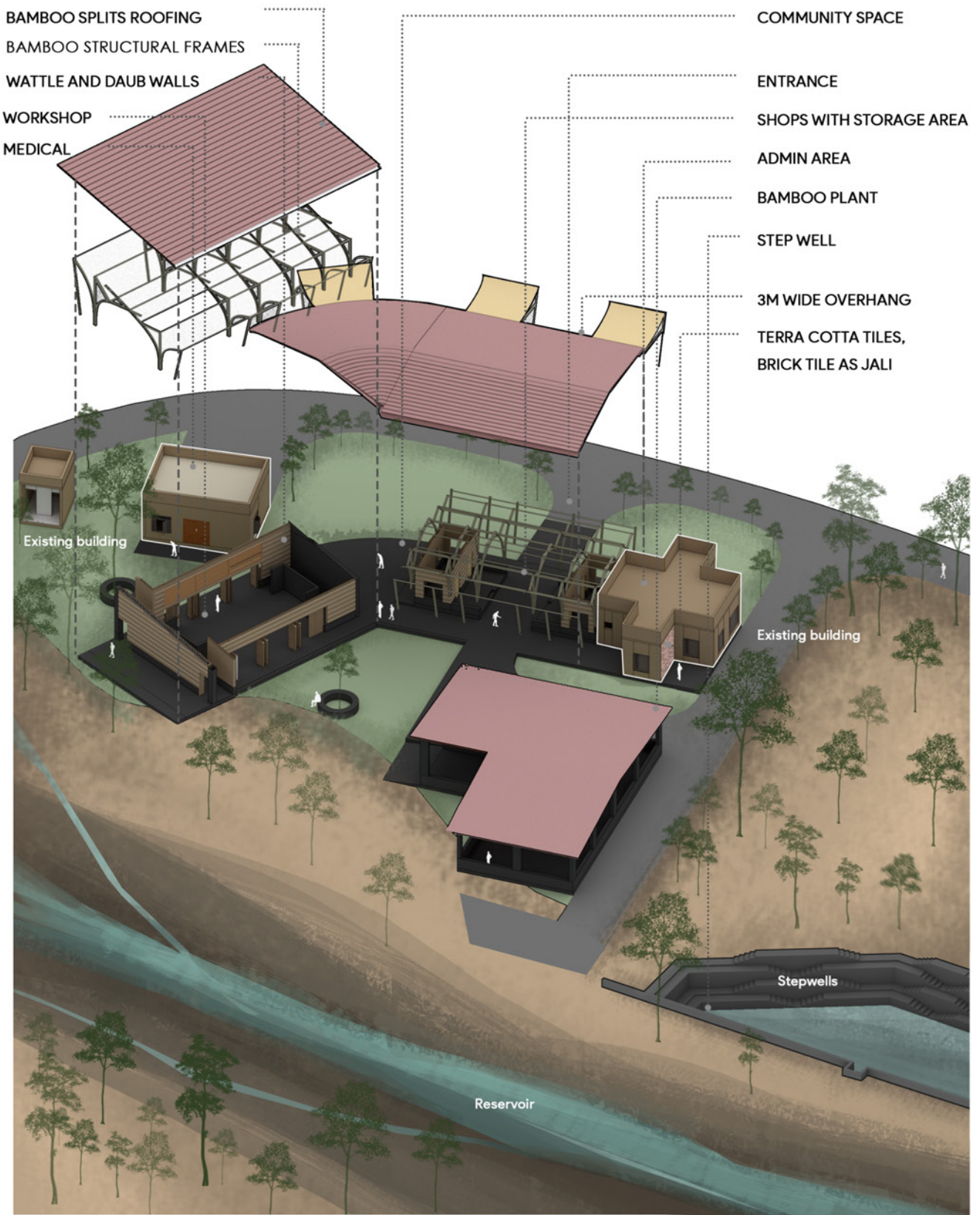

## 5.5 HEALTH AND WELL BEING

### 5.5.1 THERMAL COMFORT

The walls on the southern and western sides consist of 4 panels of bamboo, wattle and daub with a cavity in between, which acts as an insulator.

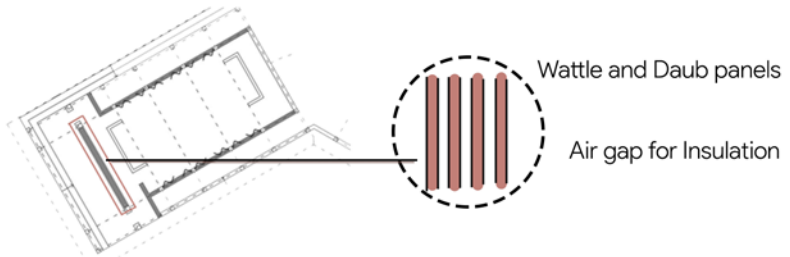

Fig. 47. Plan of Community Space

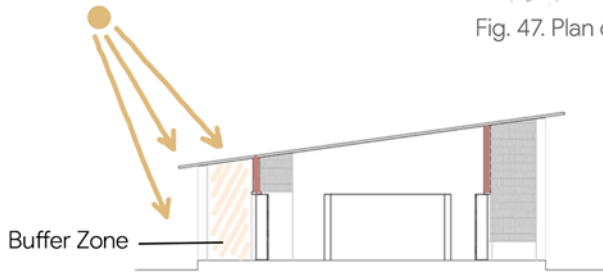

Fig. 48. Thermal Comfort 1

Large overhangs are provided which helps in protecting the walls from direct sun radiation. A shaded buffer is created outside the space.

The roof slope angle is designed to allow maximum daylight to enter the building from the north while minimizing direct sunlight from the south.

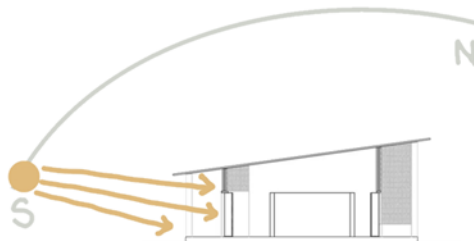

Fig. 50. Thermal Comfort 3

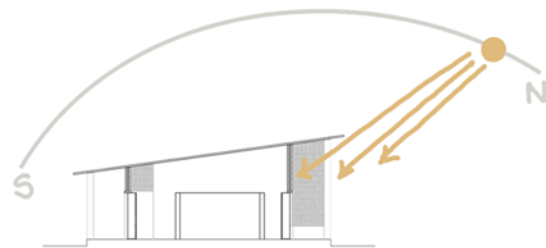

Fig. 49. Thermal Comfort 2

To provide a comfortable visual and thermal environment, the roof angle on the southern side is kept low, allowing sunlight to enter only during the evening hours when the sun is at a lower angle. This results in lower sunlight intensity, which helps reduce glare and heat gain.

### 5.5.2 VENTILATION

Planning of the structure is done so that there is good Cross ventilation.

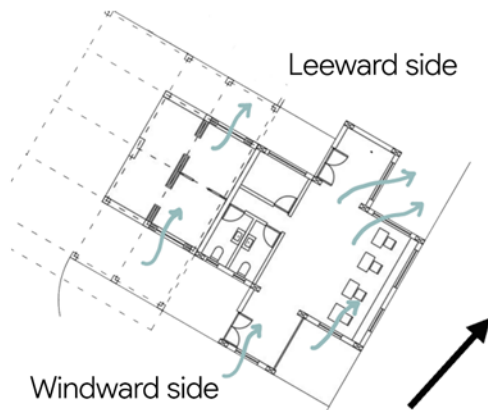

Fig. 52. Cross Ventilation 2

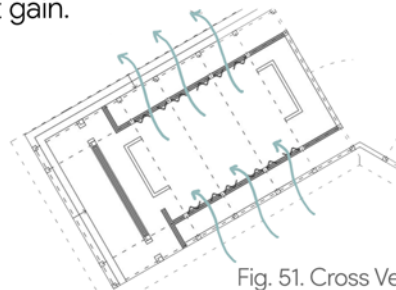

Fig. 51. Cross Ventilation

The air inlets are placed on the windward side of the structure. The size of the inlet openings are kept smaller compared to the outlets so as to cool the air entering the spaces.

The outlets are provided on the leeward side with a larger opening size. As warm air rises upwards, it escapes through the higher openings, creating a flow of air that helps to regulate the temperature inside the space.

Bamboo slits in walls provide natural ventilation, visual connection with the outdoors and promote sustainability as it is a local material. They are an easy way to enhance comfort, aesthetic appeal and regulate temperature and humidity levels in hot and humid climates.

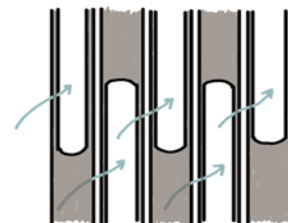

Fig. 53. Bamboo Slits





### 5.5.3 CFD SIMULATIONS

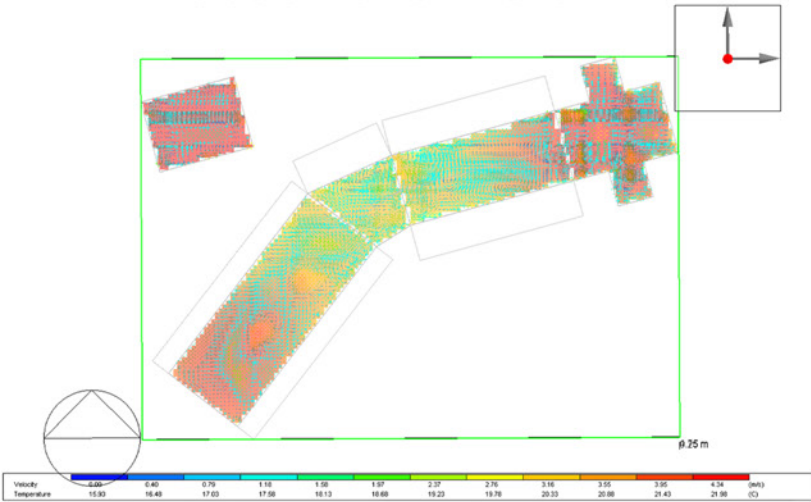

Fig. 54. CFD Simulation at 1.5m height in cut plan

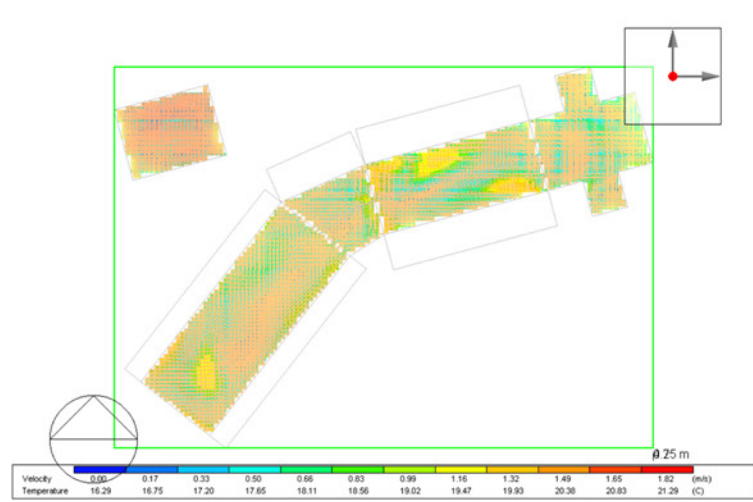

Fig. 55. CFD Simulation at 2.8m height in cut plan

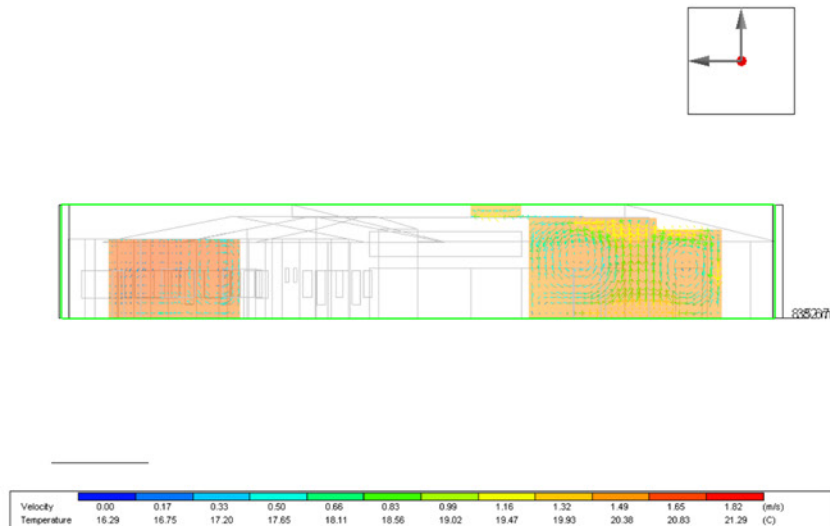

Fig. 56. CFD Simulation at in cross section

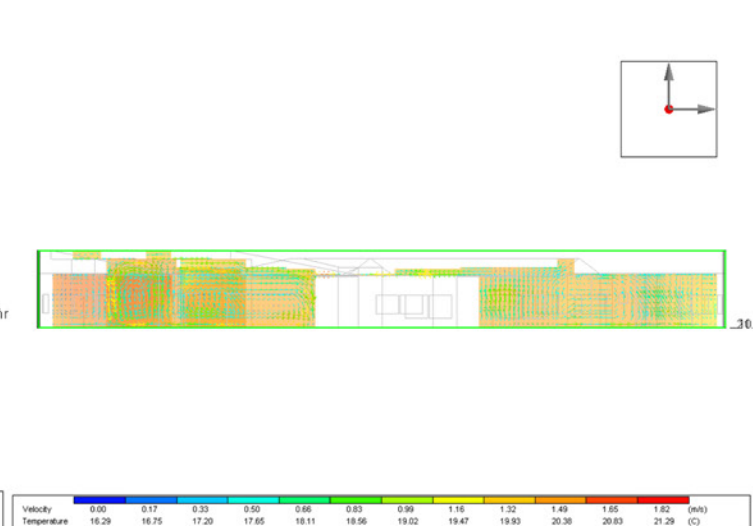

Fig. 57. CFD Simulation in cross section

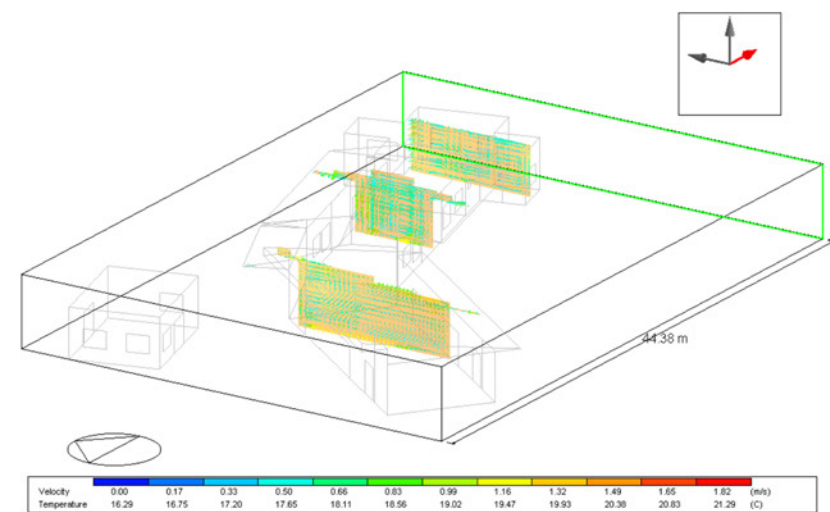

Fig. 58. CFD Simulation showing location of cross section above

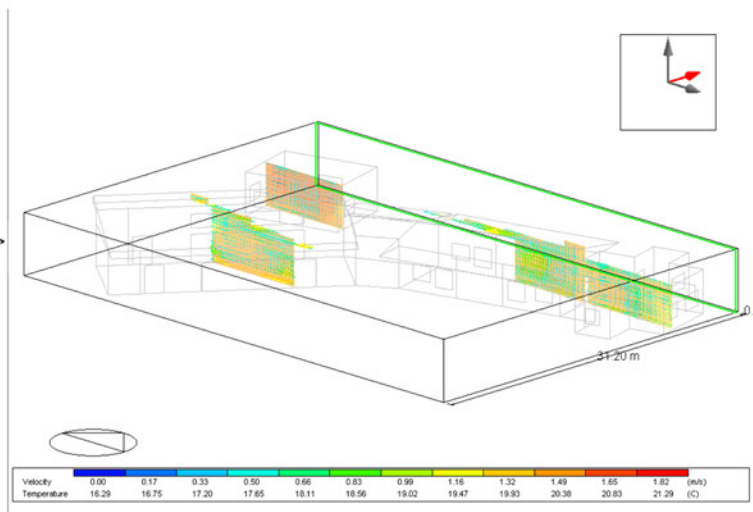
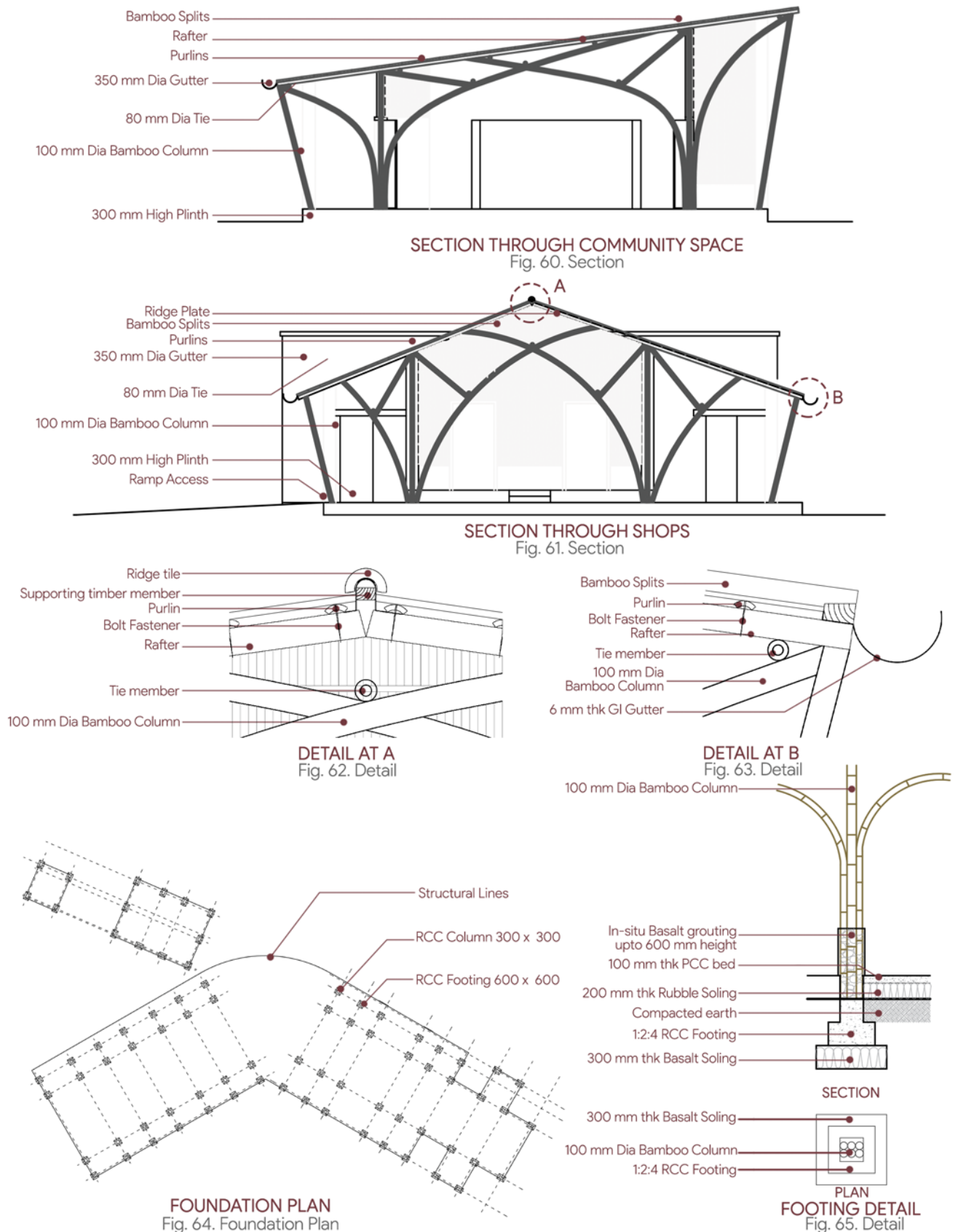

Fig. 59. CFD Simulation showing location of cross section above



## 5.6 ENGINEERING AND OPERATIONS

The structural design of our community resilience shelter is done using locally available materials such as bamboo and basalt rocks. Bamboo is used as primary load carrying member throughout the structure. Use of basalt rock is limited to foundation works and bamboo lining. Cement is used in places where in-situ grouting is mandatory. Mangalore tiles are used for roof covering. The design employs isolated footing of bamboo columns.



### 5.6.1 WORKING OF MACRO

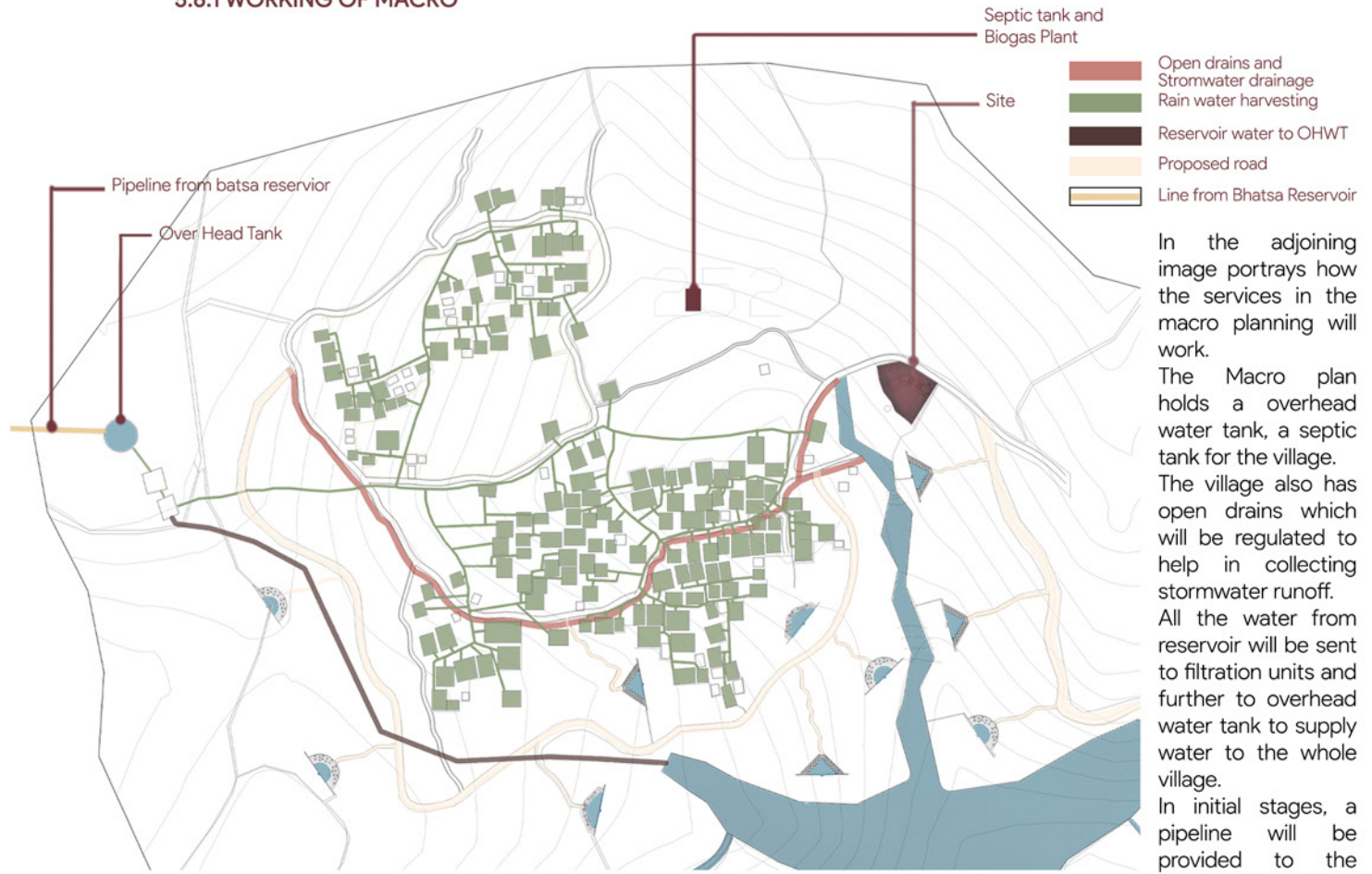

In the adjoining image portrays how the services in the macro planning will work. The Macro plan holds a overhead water tank, a septic tank for the village. The village also has open drains which will be regulated to help in collecting stormwater runoff. All the water from reservoir will be sent to filtration units and further to overhead water tank to supply water to the whole village. In initial stages, a pipeline will be provided to the village from Bhatsa reservoir to aid the rejuvenation plan

Fig. 66. Services on Macro level planning design

### 5.6.2 WORKING OF MICRO



Fig. 67. Water Supply and Drainage Layout



Fig. 68. Electrical Layout



## 5.7 INNOVATIONS

### 5.7.1 PODS

Following is the demographics of villages identified for setting up a mobile network

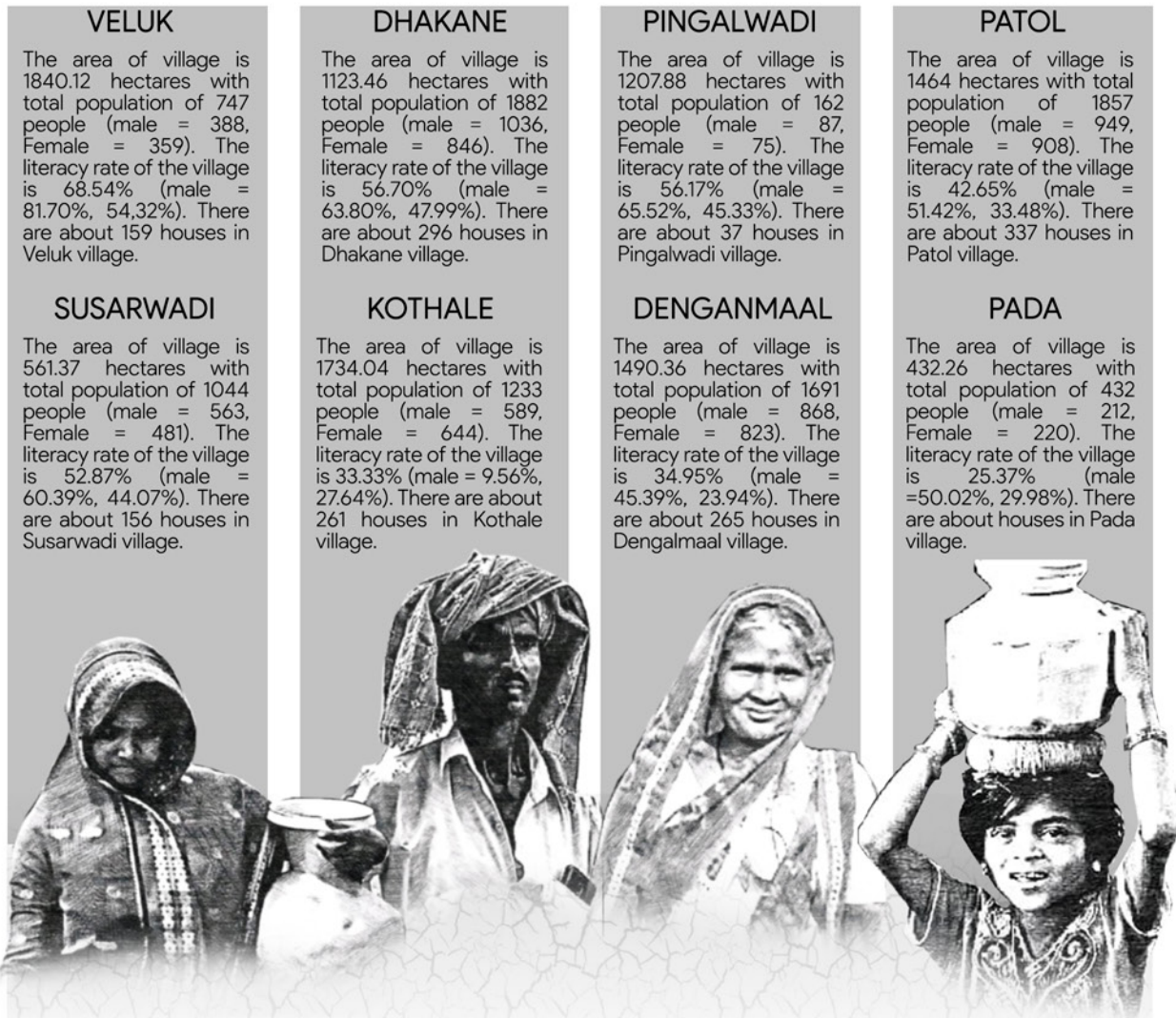

Fig. 69. Villages

Given below is the map of connected villages. These villages have been grouped around 3 hotspot villages. These villages will act as bases to deploy mobile pods to nearby villages and settlements. A calendar for the same has been given later in the report which will provide information on location of the pods.

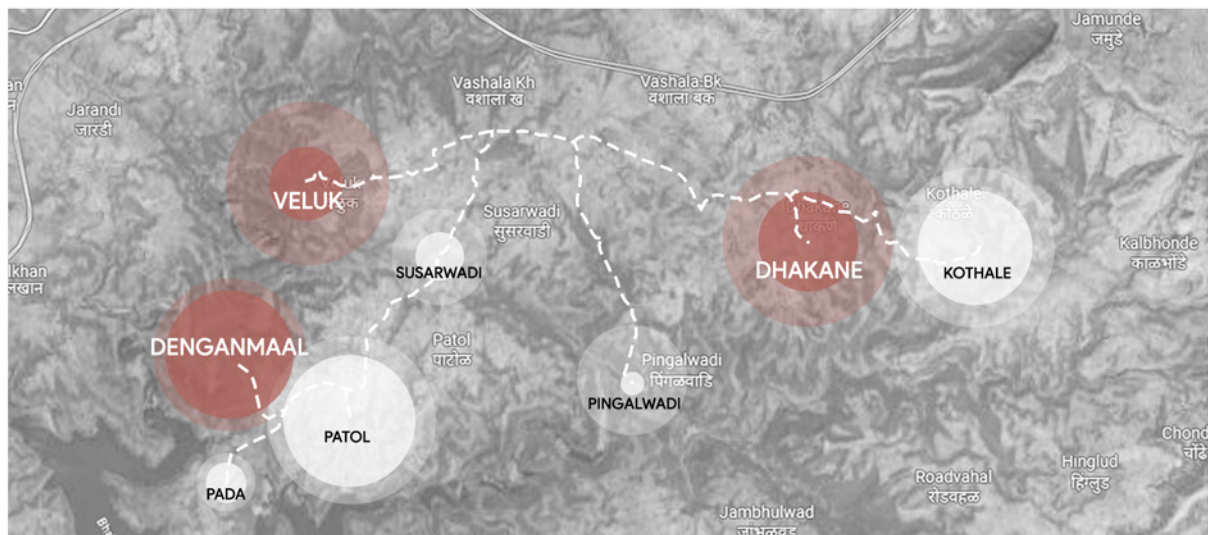

Fig. 70 .Map of Connecting villages



### 5.7.2 MOBILE PODS- PRODUCT INNOVATION

By using CSR and the government policies/ yojna, who aims with similar approach and objectivities we can manage more flexibility in funding.

#### Market potential and Scalability.

- We can create various versions of a module that can be utilized for diverse functional purposes like medical services, transportation goods, upskill and vocational programs for employment.
- The structure of the module is designed to allow for expansion by adding more space and walls on the sides to accommodate the growing needs of its users.
- The villagers can request a pod through the application or a phone call as per their requirements.

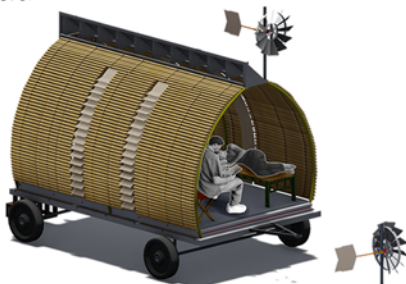

- Medical Facility**
- Regular OPD
  - Collection for checkups
  - Maternity emergency
  - Emergency OPD
  - Supplying Medicines

#### Vocal for Local

- For the locals : To the locals : By the locals
- Employment opportunities
- Homemade product business
- Employment linkage

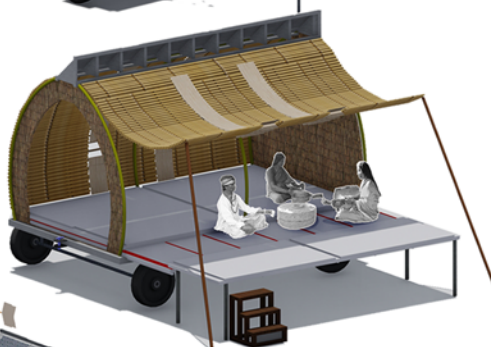

#### Ration Stop / Good Service

- Government ration shop
- Delivery package service
- Grocery supplies
- Pharmacy

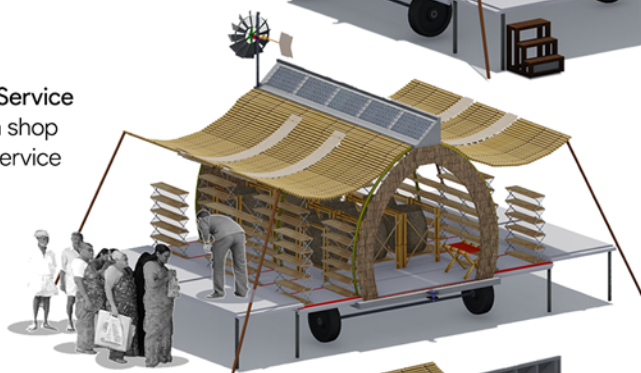

- Smart Villages**
- PCO-PCO
  - Library
  - Smart Agriculture

#### Vocational Training / Government Campaigns

- Training Workshop
- Voting Booths
- Objective Training
- Policy Awareness
- Awareness Drives
- Public Addressing
- Survey Vehicle

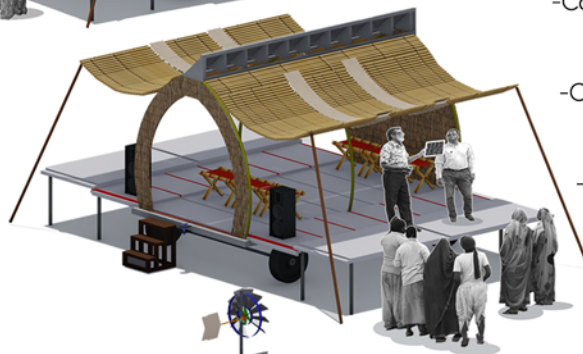

- Community Participation**
- Community Engagement
  - Community Gathering
  - Khatha Pathan
  - Bhajan Kritan
  - Children engagement activities
  - Place making
  - Knowledge Gaining
  - Game activities

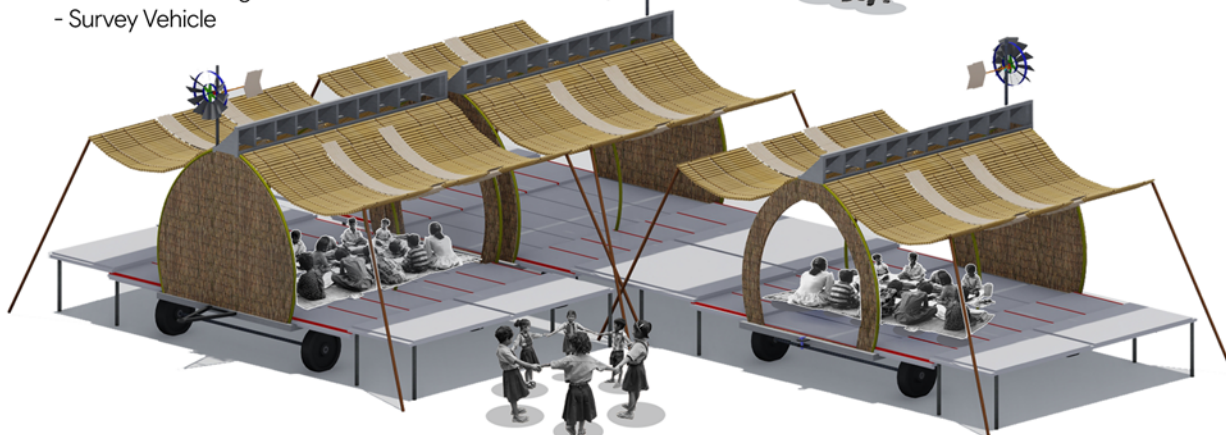

Fig. 71. Mobile Pods



### 5.7.3 FOLDABLE COMPACT BAMBOO FURNITURE

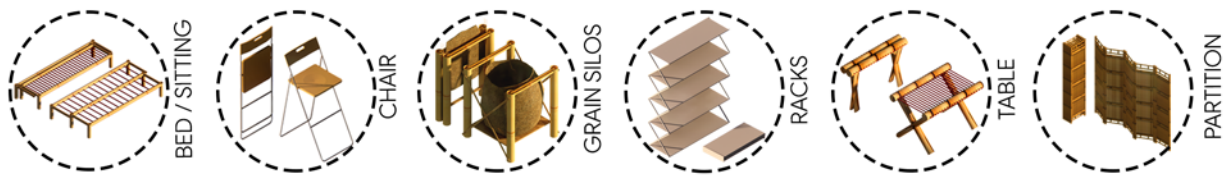
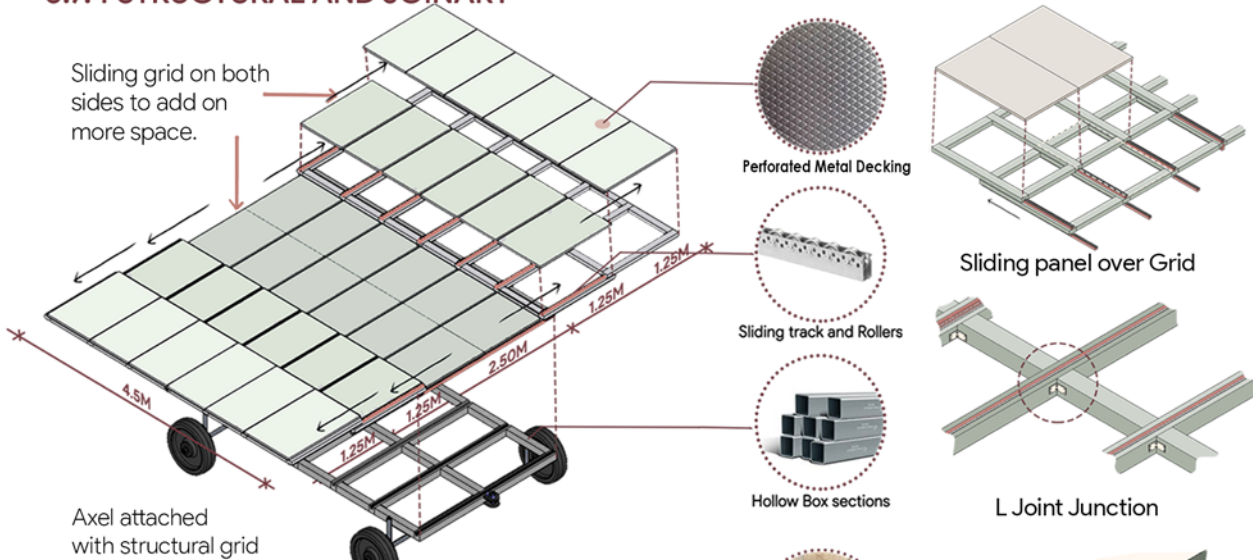
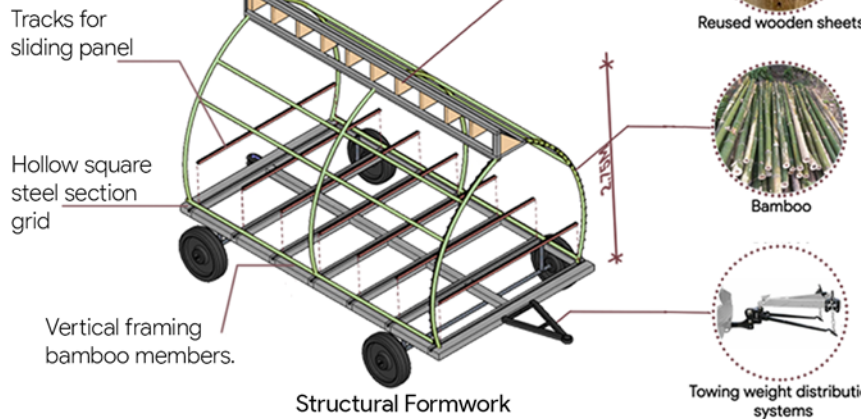

Fig. 72. Bamboo Furniture

### 5.7.4 STRUCTURAL AND JOINARY



Structural Grid  
Fig. 73. Structural Grid



Structural Formwork  
Fig. 74. Structural Formwork

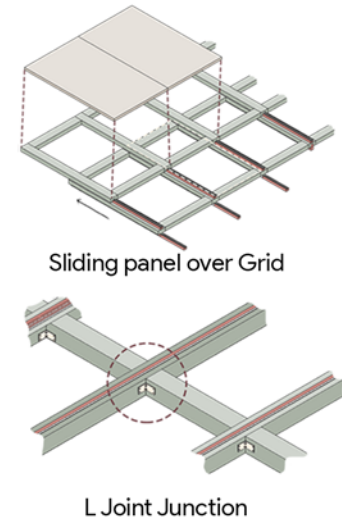
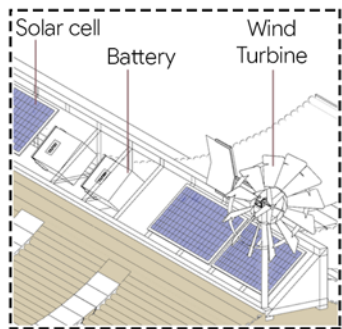
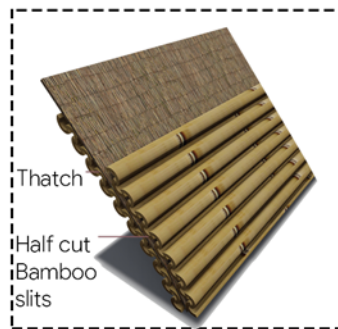

Fig. 75. Joinery Details



Self- Sustainable energy source

Fig. 76. Energy Source



Sandwich slit panel for Waterproofing

Fig. 77. Sandwich Slit

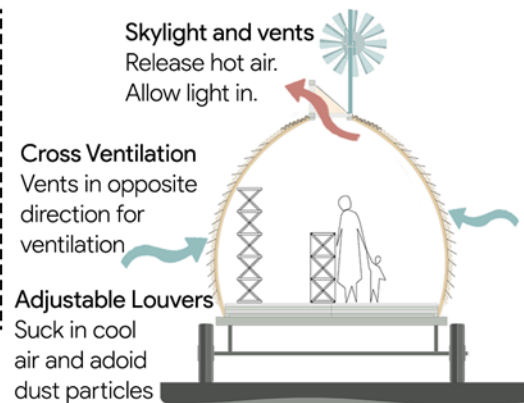

Section  
Fig. 78. Section



The Mobile pods will be operated by the villagers on build and own basis. These pods will provide basic daily amenities to the nearby villages.

## JUNE जून | VELUK वेळुक 2023

	Medical	Ration	Vocal for Local	Vocat Training	Comunity
<b>Monday</b>	Kothale Dhakane	Veluk Susarwadi Pingalvadi	Denganmal Patol Pada		
<b>Tuesday</b>	Veluk Susarwadi Pingalvadi	Denganmal Patol Pada	Kothale Dhakane		
<b>Wednesday</b>	Denganmal Patol Pada	Kothale Dhakane	Veluk Susarwadi Pingalvadi		
<b>Thursday</b>					Kothale Dhakane
<b>Friday</b>				Kothale Dhakane	Veluk Susarwadi Pingalvadi
<b>Saturday</b>				Veluk Susarwadi Pingalvadi	Denganmal Patol Pada
<b>Sunday</b>				Denganmal Patol Pada	

Table 4. Mobile Pods Calendar for 8 villages

Sunday रविवार	Monday सोमवार	Tuesday मंगळवार	Wednesday बुधवार	Thursday गुरुवार	Friday शुक्रवार	Saturday सनवार
				1	2 Vocational Training शक्तिपीक ज्ञान	3
4 Medical दवाखाना	5 Ration Shop रेशन दुकान	6 Vocal for Local लोकल	7 Medical दवाखाना	8 Ration Shop रेशन दुकान	9 Vocational Training शक्तिपीक ज्ञान	10 Community Engagement समाज एकत्र
11 Medical दवाखाना	12 Ration Shop रेशन दुकान	13	14	15	16	17
18 Medical दवाखाना	19 Ration Shop रेशन दुकान	20 Vocal for Local लोकल	21	22	23 Vocational Training शक्तिपीक ज्ञान	24 Community Engagement समाज एकत्र
25 Medical दवाखाना	26 Ration Shop रेशन दुकान	27	28 Medical दवाखाना	29 Ration Shop रेशन दुकान	30	

Table 5. Mobile Pods Calendar for 1 village

These pods will circulate between these villages to cater to their basic needs.

The calendar beside shows the dates during which the pods will be present in Veluk village. Each villager will have access to this calendar for their particular village and all the other villages. This will help them in planning there resources.

Some emergency pods will be permanently stationed at 3 villages and will cater to the nearby villages on call.

### 5.7.5 INNOVATION FOR WATER FILTERTION

**Aim** - To innovate on-site water generation sector to offset the water demand.

**Strategies**- Peloton wheel, water filtration, water collection system (an amalgamation of traditional methods and local material), water filtration through canals ( macro and micro level).

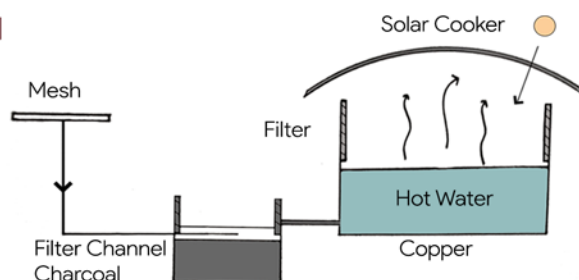

Fig. 79. Water filtration

Water purification supply system towards CRS:

The water collected from rainwater harvesting tank and reservoirs needs to filter to make it usable for human consumption. Thus, first layer of mesh cleans the hard impurities of water. Passing through bamboo canal which has layers of charcoal is pumped to Copper solar cooker which stores the water. The solar cooker has filter candles within, whereas the sunlight incident on copper vessel kills the bacteria in water. Hereafter, the water is supplied to shelter for human consumption.

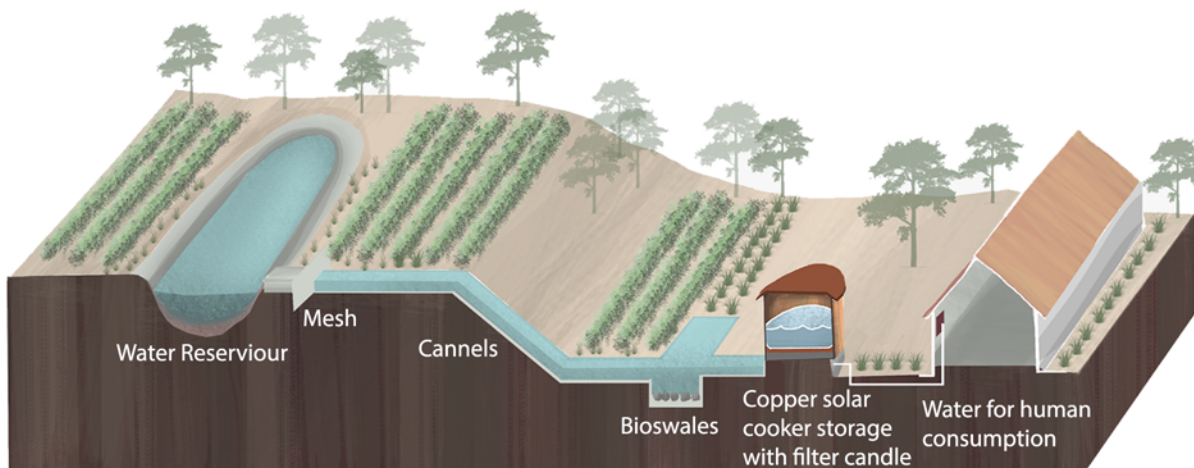

Fig. 80. Water purification supply system



## 5.8 WATER PERFORMANCE

The water cycle is divided into two: Macro water cycle and micro water cycle. Macro water cycle caters to all the water need of the village, farms, as well as economic use; whereas, micro water cycle caters to reuse of water in specific sectors namely, human consumption, farming irrigation, and bamboo curing.

### Water calculations for village

No. of people in village = 747  
 Water requirement per person per day = 135 L/day  
 Total water requirement per day =  $747 \times 135 \text{ L} = 100,845 \text{ L/day}$   
 Annual water requirement =  $100,845 \text{ L} \times 365 = 36,808,425 \text{ L}$

Annual water storage requirement for village = 36,808,425 L  
 Consider 3 months of extra water storage =  $36,808,425 + 9,076,050 = 45,884,475 \text{ L/year}$

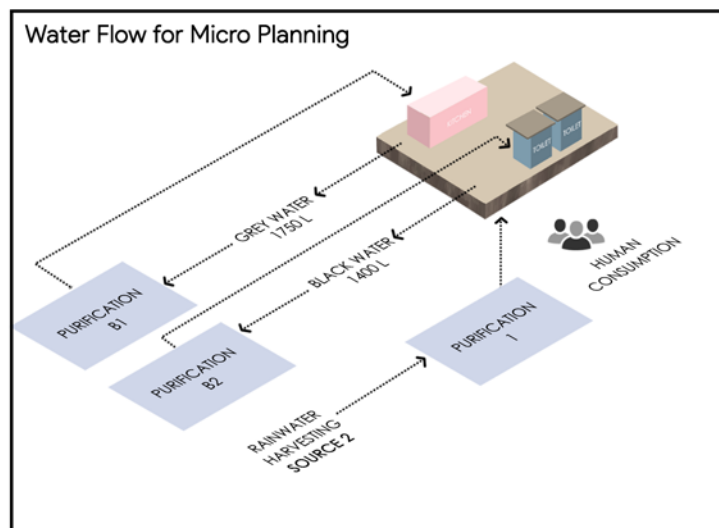

Fig. 81. Water Cycle for Micro Planning

### Water calculation for CRS

Population capacity of CRS = 230  
 No. of people using CRS daily = 70  
 Water requirement =  $70 \times 135 = 9450 \text{ L}$   
 With a factor of safety of 1.2  
 Total water storage capacity required =  $1.2 \times 9450 = 11,340 \text{ L}$   
 Annual water requirement of CRS =  $11,340 \times 365 = 4,139,100 \text{ L}$

### Water calculation for Stepwells

Water holding capacity of one stepwell = 200,000 L  
 No. of stepwells used provided = 10  
 Total water stored in stepwells =  $10 \times 200,000 = 2,000,000 \text{ L}$

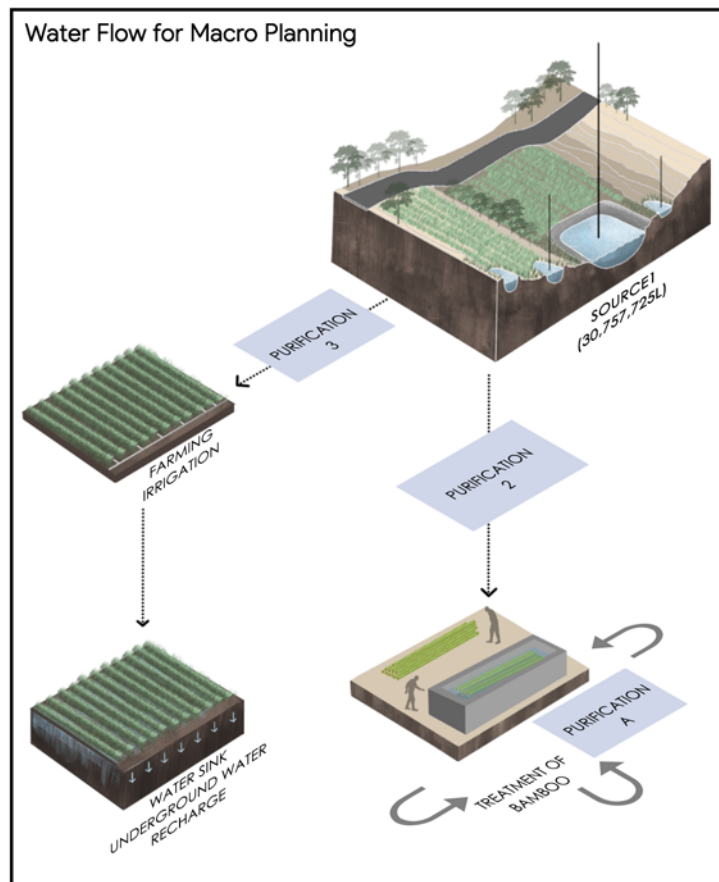

Fig. 82. Water Cycle for Macro Planning

### Rainwater Harvesting Tank Capacity

= mean annual rainfall (mm) x area(sq.m) x runoff factor  
 $= 1439 \times 2529.5$   
 Roof area = 2529.5m<sup>2</sup>, Land = 945m<sup>2</sup>

Run off factor  
 Roof = 0.9 Land = 0.3

Harvestable rainwater = mean annual rainfall (mm) x area(sq.m) x runoff factor  
 $= 1439 \times ((2529.5 \times 0.9) + (945 \times 0.3)) = 36,83,911.95 \text{ L}$

Total volume of harvestable rainwater = 3700 cu.m

Almost 50% rainwater should be reused and remaining water is allowed to seep into the soil to recharge underground water table. 1850

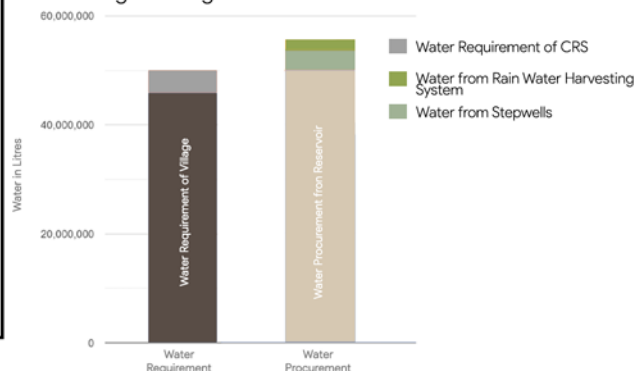

Fig. 83. Water Demand Reduction Graph





### 5.8.1 STORM WATER MANAGEMENT:

- The object of storm water drainage is to collect and carry, the rainwater collected within the premises of the building, for suitable disposal.
- Surface drain channels are been laid
- A catch basin is provided to drain out rain water free from silt, grit, debris in to a combined sewer. This should be provided along the sewer line
- Using paving tiles with open joints which enable water to percolates as it flows on it.
- Pervious pavement used to allow maximum discharge of the rainwater to flow directly or indirectly to permeate into the ground for enabling the ground water to be recharged.

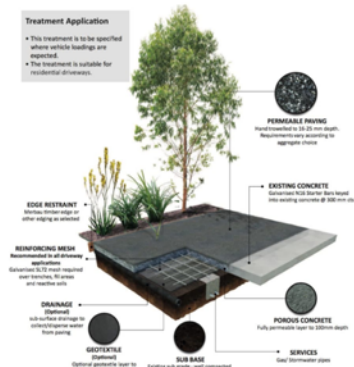

Fig. 84. Storm Water Management

### CHAUKAS:

A Chauka, meaning 'square' in Hindi, are a series of interconnected water dykes, built across a gently sloping area to collect maximum rainfall runoff. Dykes are built on three sides on the periphery of the rectangle and the other side is connected to the main water channel that is meant for overflow. With an aim to utilize every drop of rainfall, the chaukas are dug on bare land which replenish aquifers due to increased infiltration and maintain soil moisture.

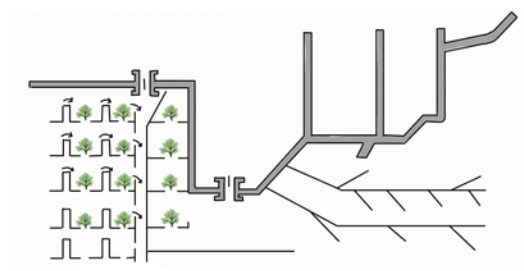

Fig. 85. Chaukas

### ULTRA LOW FIXTURES:

- Large quantities of water are saved by the use of plumbing fixtures that are designed to operate with less water.
- For instance, toilets were once made to operate using 7 gallons per flush, but are now available using only 1.3 gallons (a savings of over 80%).
- Water-saving plumbing fixtures are required in many areas by building and plumbing codes.
- There are several general approaches to the design of water-saving fixtures: low flow, dual-flush, waterless, and automatic sensor-type.



Fig. 86. Ultra Low Fixtures

### ROOT ZONE TREATMENT:

Root zone treatment is an engineered method of purifying waste water as it passes through artificially constructed wetland area. It is considered as an effective and reliable secondary and tertiary treatment method. The pollutants are removed by various physical, chemical and biogeochemical processes like sedimentation, absorption, and nitrification as well as through uptake by wetland plants. The root zone wastewater treatment undertakes the following steps:

The essential components of the systems are:

- The reed type of wetland plants.
- The soil bed.
- Micro-organisms of different type.

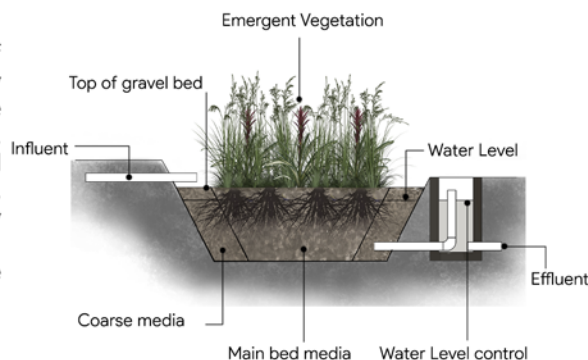

Fig. 87. Root Zone Treatment

### SMART METER:

- Smart meters are connected through a web-based monitoring system which will help to reduce commercial losses of utilities, enhance revenues and serve as an important tool in power sector reforms.
- Save money with smart meters



Fig. 88. Smart Meter



Fig. 89. Smart Meter

## 5.9 ENERGY PERFORMANCE

**Aim :** to generate more energy on-site to offset the grid source energy consumption which reduces environmental footprint. **Net Positive Performance:** Generating more offset energy on-site than required. To maximize the energy performance of building, there are two components reducing energy consumption and simultaneously increasing energy generation

### U VALUE:

WALL 1				
SR NO	MATERIAL	THICKNESS	THERMAL CO	R = t/k
1	BASALT	0.2	1.2	0.1667
2	WATTLE AND DAUB	0.05	0.05	1.0000
3	EXTERIOR			0.0400
4	INTERIOR			0.1300
5	WATTLE AND DAUB	0.05	0.05	1.0000
6	AIR	0.02	0.024	0.8333
			R	3.1700
			U	0.3155
WALL 2				
SR NO	MATERIAL	THICKNESS	THERMAL CO	R = t/k
1	BASALT	0.45	1.2	0.3750
2	WATTLE AND DAUB	0.05	0.05	1.0000
3	EXTERIOR			0.0400
4	INTERIOR			0.1300
5	WATTLE AND DAUB	0.05	0.05	1.0000
6	WATTLE AND DAUB	0.05	0.05	1.0000
7	AIR	0.02	0.024	0.8333
			R	4.3783
			U	0.2284
FLOOR				
SR NO	MATERIAL	THICKNESS	THERMAL CO	R = t/k
1	BASALT	0.6	1.2	0.5000
2	BAMBOO	0.2	0.35	0.5714
3	COWDUNG	0.01	0.05	0.2000
4	BAMBOO	0.2	0.35	0.5714
			R	1.8429
			U	0.5426
ROOF				
SR NO	MATERIAL	THICKNESS	THERMAL CO	R = t/k
1	TILES	0.02	1.00	0.020
2	ATTIC SPACE	0.05	0.11	0.455
3	BULK INSULATION	0.015	0.01	1.500
4	BAMBOO	0.01	0.35	0.029
7	AIR	0.02	0.024	0.8333
			R	2.8365
			U	0.35255

Table 6. U- Value calculation of materials

### WWR:

WINDO W NO.	SILL LVL	LINTEL LVL	WIDTH	HEIGHT	SIZE (LxB)	AREA	OPENABLE AREA	TOTAL WINDOW AREA	NO. OF WIND OWS	TOTAL WINDOWS AREA
EAST										
W1	0.6	2.1	2	1.5	2 x 1.5	3	80%	2.4	6	14.4
W2	0.6	2.1	1.2	1.5	1.2 x 1.5	1.8	100%	1.8	1	1.8
W3	0.6	2.1	1.5	1.5	1.5 x 1.5	2.25	80%	1.8	1	1.8
D5	0	2.1	2.55	2.1	2.55 x 2.1	5.355	80%	4.284	1	4.284
D6	0	2.1	3	2.1	3 x 2.1	6.3	80%	5.04	1	5.04
										27.324
SOUTH										
W1	0.6	2.1	2	1.5	2 x 1.5	3	60%	1.8	2	3.6
W2	0.6	2.1	1.2	1.5	1.2 x 1.5	1.8	80%	1.44	3	4.32
W3	0.6	2.1	1.5	1.5	1.5 x 1.5	2.25	60%	1.35	1	1.35
D4	0	2.1	2	2.1	2 x 2.1	4.2	100%	4.2	1	4.2
										9.87
WEST										
W1	0.6	2.1	2	1.5	2 x 1.5	3	60%	1.8	2	3.6
W3	0.6	2.1	1.5	1.5	1.5 x 1.5	2.25	60%	1.35	2	2.7
D1	0	2.1	1.5	2.1	1.5 x 2.1	3.15	100%	3.15	1	3.15
D3	0	2.1	1.6	2.1	1.6 x 2.1	3.36	100%	3.36	1	3.36
D5	0	2.1	2.55	2.1	2.55 x 2.1	5.355	80%	4.284	2	8.568
D6	0	2.1	3	2.1	3 x 2.1	6.3	80%	5.04	1	5.04
										26.418
NORTH										
W1	0.6	2.1	2	1.5	2 x 1.5	3	60%	1.8	2	3.6
D4	0	2.1	2	2.1	2 x 2.1	4.2	80%	3.36	1	3.36
										6.96

FACADE	WWR
EAST	19%
SOUTH	13.70%
WEST	27.40%
NORTH	18.80%

Table 7. WWR Calculation

### 5.9.1 CONSTRUCTION ELEMENTS AND DESIGN STRATEGIES USED TO REDUCE HEAT

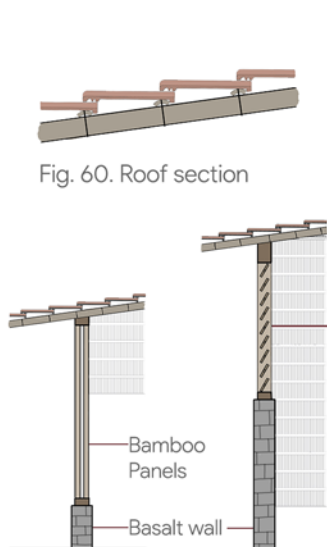

Fig. 60. Roof section

Fig. 90. Wall sections

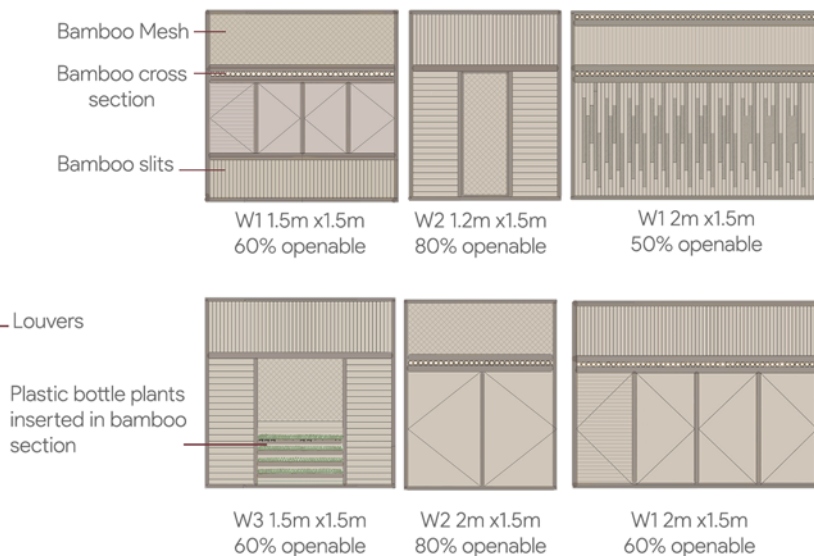

Fig. 91. Windows design elevation



### 5.9.2 ENERGY CONSUMPTION

ENERGY CONSUMPTION								
BASE CASE								
	LEGEND	APPLIANCES	No. of Fixtures	WATTAGE	NO.OF HOURS USED	Daily energy consumption	Annual energy consumption (Whr/yr)	Kilowatt-hours per year
1	LIGHTING	LED BULB	14	9	8	1008	367920	367.92
		LED BULB	9	12	8	864	315360	315.36
2	FANS	FAN	22	45	8	7920	2890800	2890.8
3	PUMPS	OHWT	2	150	0.4	120	43800	43.8
		bamboo curi	1	150	0.3	45	16425	16.425
4	EQUIPMENTS	Laptop	3	55	4	660	240900	240.9
		printer	1	40	0.3	12	4380	4.38
		refrigerator	1	50	24	1200	438000	438
<b>TOTAL</b>						<b>11829</b>	<b>4317585</b>	<b>4317.585</b>
						11.829 kWh/day		
PROPOSED CASE								
	LEGEND	APPLIANCES	No. of Fixtures	WATTAGE	NO.OF HOURS USED	Daily energy consumption	Annual energy consumption	Kilowatt-hours per year
1	LIGHTING	LED BULB	7	9	4	252	91980	91.98
		LED BULB	5	12	4	240	87600	87.6
2	FANS	FAN	10	45	2	900	328500	328.5
3	PUMPS	OHWT	2	150	0.4	120	43800	43.8
		bamboo curi	1	150	0.3	45	16425	16.425
4	EQUIPMENTS	Laptop	3	55	4	660	240900	240.9
		printer	1	40	0.3	12	4380	4.38
		refrigerator	1	50	24	1200	438000	438
<b>TOTAL</b>						<b>3429</b>	<b>1251585</b>	<b>1251.585</b>
						3.429 kWh/day		

Table 8. Energy consumption table

The EPI of base case is 45.55 kWh/m<sup>2</sup>  
 The EPI of proposed case is 20.61 kWh/m<sup>2</sup>

That is 45.24% reduction in the Energy Performance Index

There has been a 71% reduction in energy consumption itself by using more efficient electrical appliances than the base case which is then coupled with using passive design strategies to maximize the natural daylighting so that the number of appliances required will be less.

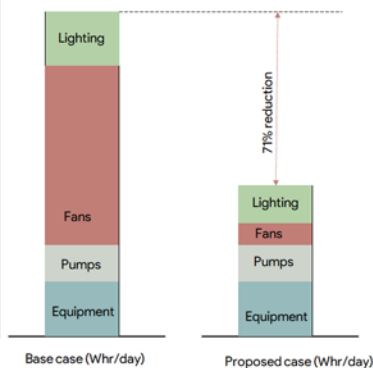

Fig. 92. Energy consumption graph

### 5.9.3 ENERGY GENERATION

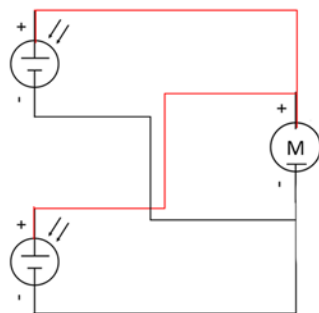

Fig. 93. Circuit diagram for solar trackers

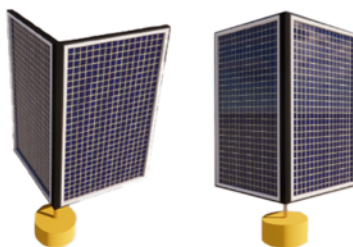

Fig. 94. system of solar trackers panels

	Total Energy [kWh]	Energy Per Total Building Area [kWh/m <sup>2</sup> ]
Total Site Energy	11203.69	20.61
Net Site Energy	11203.69	20.61
Total Source Energy	35482.08	65.28
Net Source Energy	35482.08	65.28

	Total Energy [kWh]	Energy Per Total Building Area [kWh/m <sup>2</sup> ]
Total Site Energy	24760.20	45.55
Net Site Energy	24760.20	45.55
Total Source Energy	78415.54	144.26
Net Source Energy	78415.54	144.26

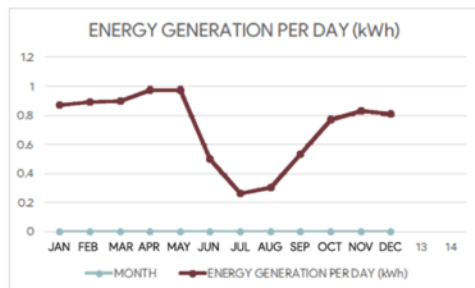

Fig. 95. Energy generation per day graph

MONTH	SUNHOURS	ENERGY(100 W) GENERATION OF PV PANEL IN 1HR	ENERGY GENERATION (kWh) per month	ENERGY GENERATION PER DAY (kWh)
January	270	27000	27	0.87
February	250	25000	25	0.89
March	280	28000	28	0.90
April	290	29000	29	0.97
May	300	30000	30	0.97
June	150	15000	15	0.50
July	80	8000	8	0.26
August	90	9000	9	0.30
September	160	16000	16	0.53
October	240	24000	24	0.77
November	250	25000	25	0.83
December	250	25000	25	0.81
<b>TOTAL</b>	<b>2610</b>	<b>261000 W</b>	<b>261</b>	<b>8.61</b>

Table 9. Energy generation from solar panel calculation



### 5.9.4 ILLUMINANCE SIMULATIONS (BASE CASE, PROPOSED CASE)

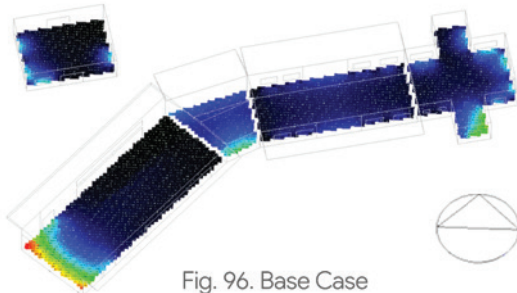

Fig. 96. Base Case

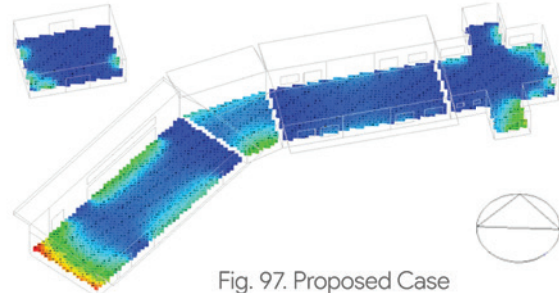

Fig. 97. Proposed Case



Fig. 98. Legend

### 5.9.5 DAYLIGHT SIMULATIONS (BASE CASE, PROPOSED CASE)

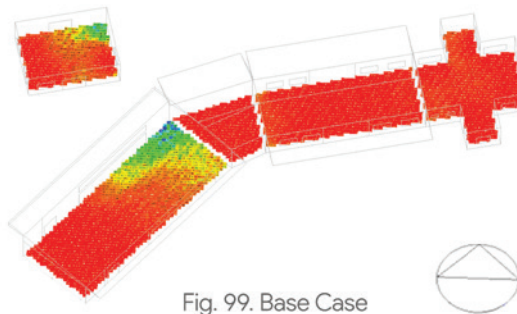

Fig. 99. Base Case

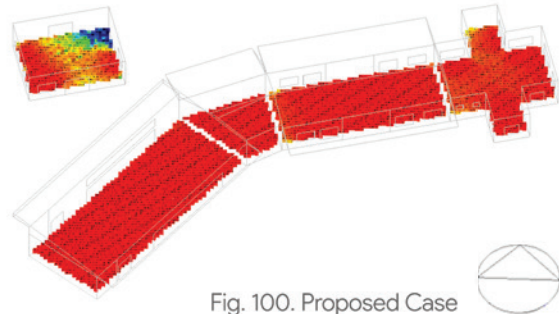

Fig. 100. Proposed Case

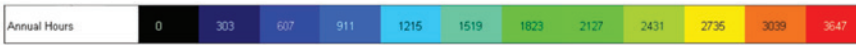

Fig. 101. Legend

Daylight autonomy benchmarks for percentage hours exceeding 300lux for building typologies office and healthcare is averaged, to 35% Daylight Autonomy Annual Analysis Hours Benchmarks (reference GRIHA 10.1 Appraisal)

### 5.9.6 THERMAL COMFORT AND THERMAL COMFORT HOURS SIMULATION (PROPOSED CASE)

The graph below has been simulated in Design Builder and shows a number of parameters from air temperature to relative humidity. Table alongside shows number of comfort hours NOT MET i.e. Total number of **comfort hours achieved** adds up to **5110 out of 5110 hrs., for the occupancy of 8am to 9pm for 365 days.**

Comfort and Setpoint Not Met Summary

	Facility [Hours]
Time Setpoint Not Met During Occupied Heating	0.00
Time Setpoint Not Met During Occupied Cooling	0.00
Time Not Comfortable Based on Simple ASHRAE 55-2004	2817.00

Fig. 102. Comfort hours NOT MET

SR. NO.	SPACE	DESCRIPTION	AREA (SQ.M)	NO.	TOTAL AREA	NO. OF PEOPLE	OCCUPANCY DENSITY	AIR CHANGES PER HOUR (NBC)
<b>SHELTER A</b>								
<b>Training and Economic Hub of CRS</b>								
1	Administrative Space* (with toilets and record room)	Existing RCC structure retrofitted Toilets of 4.5 sqm. area Record room 9 sqm. area	72	1	72	6	0.08	8
2	Shops (with storage)	Retail front for mobile supply chain	15	4	60	10	0.17	4
3	Multipurpose Space	Community Center/ Workshops/ Training Space	125	1	125	40	0.32	10
4	Congregation Space	Gathering Space for all seasons, festivities and cultural activities	60	1	60	30	0.50	10
<b>SHELTER B</b>								
<b>Medical Facility*</b>								
5	Waiting Area*	Designated		1				
6	Out patient Department*	Existing RCC structure retrofitted with equipments, partitions, and 4 beds to function as a medical facility	10	1	10	4	0.40	10
7	General Ward*		30	1	30	6	0.20	22
8	Medical Shop*		8	1	8	4	0.50	8

Table 10. Ventilation calculations showing air changes per hour

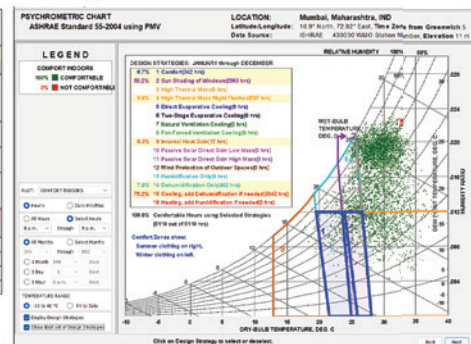

Fig. 103. Comfort hours NOT MET

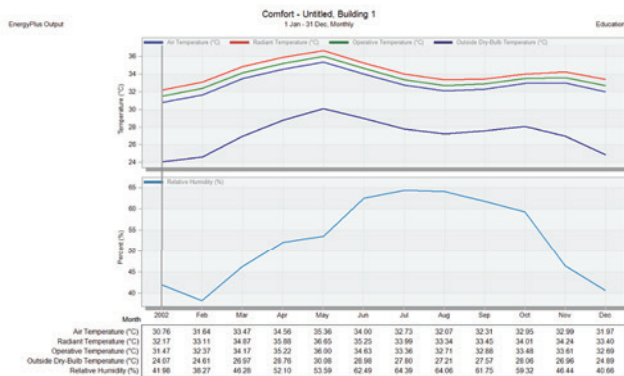

Fig. 104. Thermal comfort simulation graph

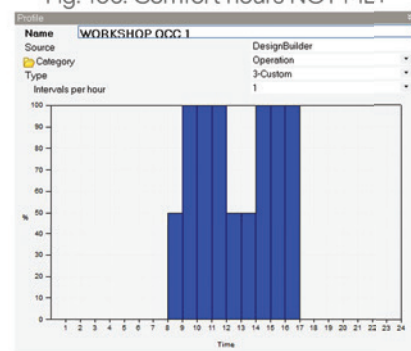

Fig. 105. Thermal comfort simulation graph

## 5.10 RESILIENCE

### 5.10.1 POTENTIAL RISK

Climate change leads to rising temperatures, water evaporation, droughts, vegetation loss, soil erosion, and lower crop yields, affecting livelihoods.

Women in the village experience health problems such as joint pains, degrading bone densities, and spine conditions due to long and strenuous trips on rocky terrain to fetch water.

Water scarcity in the village has led to men marrying multiple times to collect more water and a loss of occupation due to sustained droughts, resulting in social and educational challenges for the community.



Fig. 107. Potential Risk

#### 1. Water

**P:** Water scarcity is caused by the drought in the region, and the lack of awareness and conservation techniques. Villagers do not harvest rainwater or provide storage facilities.

**S:** To address water scarcity, villagers can use rainwater harvesting techniques and traditional methods such as zabo, surangam, and panam keni. Innovative systems for water management can also be implemented, and proper education facilities can promote social stability.

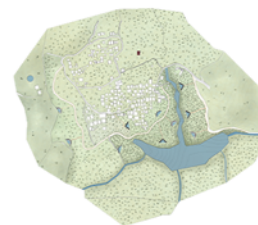

Fig. 108. Water Map

#### 2. Food Security

**P:** Water scarcity leads to food security issues in the village, with dry crops cultivated after the monsoon season. Main sources of food include rice, root vegetables, and forest vegetables from the nearby ghat terrain.

**S:** Crop rotation can conserve water, maintain soil fertility, and control pests and diseases while improving economic returns. Villagers' nutrition cycle can be incorporated into communal food-sharing spaces for events and activities.



Fig. 109. Food Security

#### 3. Network Establishment Through Pods

**P:** Lack of resources and water creates a blockade, with basic needs requiring long travel. Lack of management skills and daily living skills adds to the complexity. Healthcare, education, ration supplies, and gathering places are also lacking.

**S:** A network of pods can connect villages and people, increasing community participation and understanding, and providing access to basic amenities.

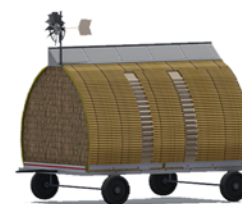

Fig. 110. Mobile Pods

#### 4. Waste Management

**P:** No drains, garbage or sewage management in the village. Waste is mixed with soil, polluting it.

**S:** Septic tanks, reed bed system and Bio-Gas plant provided in the project.

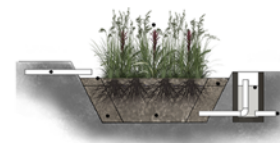

Fig. 111. Reed Bed

#### 5. Economy

**P:** Lack of business and employment opportunities in the village, leading to most men working as farm laborers for minimum wage. Absence of cattle farming due to water shortage and limited farming activities.

**S:** The design will contribute to the community's improvement by creating jobs for women through medical facilities and the development of small-scale enterprises for bamboo items, for men through farming and employment possibilities, and for kids through vocational training and education.



Fig. 112. Economy



### 5.10.2 BUSINESS

- The production of bamboo in the village will create numerous employment and economic opportunities.



#### Bamboo Artifacts

Bamboo slits are used to make such artifacts, which then can be sold in commercial as well as online market. Products like baskets, pots, and decorative artifacts are in demand these days for home decor.



#### Bamboo Construction

Providing training to masons for constructing sustainable buildings using bamboo. Traditional methods are used to join bamboo poles or slits together to create durable, cost-effective, and aesthetically pleasing structures.



#### Bamboo Weaving

Bamboo weaving is the process of using bamboo strips or slits to create various products. It involves weaving or braiding the bamboo strips together using various techniques to form intricate patterns and designs.



#### Bamboo Charcoal

Production of bamboo charcoal which can be then expanded to target larger markets for sale. bamboo charcoal has a huge market for tandoor and barbecue pits in restaurants. making a chain of production will generate profit.



#### Home Business

Women in village have a hobby to make things at home such as pickle, papad, dried products, and different types of eateries. These products have a large market in cities from which they can earn.



#### Sewing

Women have a skill in themselves of sewing. They collectively can form a startup for production of fabric, can sell their products on E-cart and commercial market. Such skills are in demand and audience like handmade fabric products.



#### Seed Bank

A seed bank stores and preserves seeds of various plant species for future use, protecting genetic diversity and endangered species while providing a source of seeds for research and agriculture.

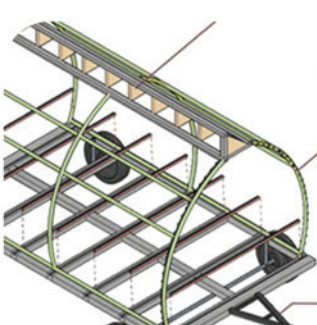

#### Pod

A mobile network of pod will help in providing daily essentials such as daily products and vocal for local: local small scale businesses can be circulated in villages which can help in generating small revenue and marketing of product



#### Pottery Artisans

There are few people in village which have their own built up skills while using mud. They can provide workshops, training secession to create ceramic objects using molding, throwing, glazing, and firing techniques.



#### Bamboo Artisans

Bamboo artisans create art and craft items using bamboo, including furniture, decor, and household items. They use weaving, bending, and carving techniques and bamboo's sustainability makes it an eco-friendly choice.



## 5.11 EMOIDED CARBON

Embodied carbon reduction strategies in our design proposal are methods that reduce the carbon footprint of building materials and construction processes. Embodied Carbon of proposed case is reduced by 67.30% . Equivalent CO2 of proposed case is reduced by 59.29%. These are further offsetted by procuring materials on site itself and existing RCC structures have been retrofitted and repurposed into working spaces. Furthermore, the plantation in macro planning will act as a carbon sink in a few years.

Here are some strategies which reduce embodied carbon in the built environment:

### MATERIAL SELECTION

Choose building materials with a lower carbon footprint. Bamboo, wattle and daub, mangalore tiles, basalt, vernacular materials locally available on-site reduces the carbon footprint for design.

### DESIGN FOR RESUSE AND RECYCLE

Community Resilience Shelter is designed with the goal of making materials reusable or recyclable at the end of their useful life. This will reduce the need for new materials to be produced. Basalt erected durinf during foundation is usde in walls till plinth level. Recycling waste from village, such as broken mangalore tiles are used in panels with water drip system to cool the space.

### USE RENEWABLE ENERGY SOURCE

Design proposed with the Use renewable energy sources, such as solar, wind, to power construction activities and building operations. Whereas, installing solar PV panels with solar tracker to maximize the solar gain incident on panels, installing the wind turbine on mobile pods.

### OPTIMIZE CONSTRUCTION PROCESS

We have optimized construction processes to minimize material waste and energy use. This is achieved through efficient project planning, use of vernacular materials, and construction techniques, labours cost reduction by training the villagers and other strategies.

Constructions Embodied Carbon and Inventory	Area (m2)	Embodied Carbon (kgCO2)	Equivalent CO2 (kgCO2)
ROOF	428.0	119340.7	119631.8
External floor - Energy code standard - Medium weight	170.4	1326.6	1378.1
115mm single leaf brick (plastered both sides)	75.5	3991.6	4178.4
Wooden door	14.7	0.0	0.0
WALL WATTLE N DAUB	331.6	12799.6	12996.2
Roof Attic & Other Steel Joists R-35 (6.2) U-0.037 (0.21)	122.0	0.0	0.0
Ground floor slab - Energy code standard - Medium weight	373.1	10083.4	12708.4
Sub Total	1515.2	147541.93	150892.85

Glazing Embodied Carbon and Inventory	Area (m2)	Embodied Carbon (kgCO2)	Equivalent CO2 (kgCO2)
Sgl Clr 6mm	211.8	3812.8	3812.8
Local shading		0.0	0.0
Window shading		0.0	0.0
Sub Total	211.8	3812.8	3812.8

Building Total	Area (m2)	Embodied Carbon (kgCO2)	Equivalent CO2 (kgCO2)
Building Total	1727.1	151354.7	154705.6

Table 11. Base case Embodied carbon estimation on design builder

Constructions Embodied Carbon and Inventory	Area (m2)	Embodied Carbon (kgCO2)	Equivalent CO2 (kgCO2)
Clay tiles (25mm) on air gap (20mm) on roofing felt (5mm)	428.0	11815.9	12243.9
External floor - Energy code standard - Medium weight	170.4	1326.6	1378.1
Lightweight 2 x 25mm gypsum plasterboard with 100mm cavity	75.5	407.5	441.5
Wooden door	52.8	0.0	0.0
Brick/block wall (insulated to 1995 regs)	333.7	20775.9	27624.8
Flat roof U-value = 0.25 W/m2K	122.0	1985.7	5484.4
Ground floor slab - Energy code standard - Medium weight	373.1	10083.4	12708.4
Sub Total	1555.5	46395.04	59881.06

Glazing Embodied Carbon and Inventory	Area (m2)	Embodied Carbon (kgCO2)	Equivalent CO2 (kgCO2)
Sgl Clr 6mm	171.6	3088.9	3088.9
Local shading		0.0	0.0
Window shading		0.0	0.0
Sub Total	171.6	3088.9	3088.9

Building Total	Area (m2)	Embodied Carbon (kgCO2)	Equivalent CO2 (kgCO2)
Building Total	1727.1	49483.9	62969.9

Table 12. Proposed case Embodied carbon estimation on design builder

### IMPLEMENT CARBON OFFSETTING

Offset embodied carbon emissions by investing in carbon offset projects, such as reforestation and renewable energy projects. Converting the drought prone region to the green lush vegetation by plantation in 15 years. Renewable source of water is reservoir and macro level planning of village to conserve and store water.

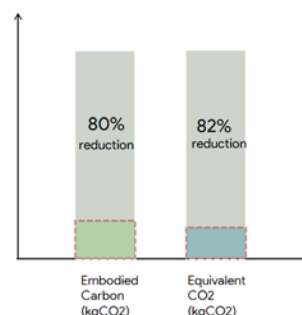

Fig. 112. Embodied carbon graphs



## 5.12 VALUE PROPOSITION

### 5.12.1 SUMMARY OF VALUE PROPOSITIONS

- 1. Water Conservation and rejuvenation of the village** - A significant water reservoir and staged stepwell development have been proposed in order to provide year-round water needs. The bigger reservoir will help in the village's revitalization even further.
- 2. Economy generation especially for women** - Training spaces and many home business opportunities have been proposed that will act as catalyst for boosting their economy and promoting their skills to world via local distributors and e-commerce shopping website.
- 3. Vocational and skill improvement courses** - The multipurpose spaces in CSR will be used by villagers and visitors for vocational training and educational activities are proposed for all user groups.
- 4. Catering to the basic needs of surrounding villages** - From a no. of 852 to 8756 people, Mobile Pods will serve to a network of 8 villages surrounding Veluk to provide them with basic amenities. Which are currently 12 km's away from their village.
- 5. Converting this village as a tourism spot in the future** - A great tourist attraction has a large water feature, an active community centre, and a positive storyline, hence this can set an example and model village for other villages around Maharashtra to come up with similar solutions suitable for their condition.
- 6. Collaboration with PAANI foundation for macro planning** will encourage the villagers to put their hands together for better quality of life.
- 7. Government policies that are implemented in the project** will allow government participation and make effective use of their policies. This could help in lowering direct project cost and covering it under such Government Policies.

### 5.12.2 GOVERNMENT POLICIES



**उन्नत भारत अभियान 2.0**  
UNNAT BHARAT ABHIYAN 2.0

Basic Amenities  
Artisans, Industries and Livelihood  
Water Management  
Renewable Energy  
Organic Farming  
National Coordinating Institute  
Indian Institute of Technology, Delhi  
A Program of  
Department of Higher Education,  
Ministry of Human Resource Development,  
Government of India

**NDA Govt launches a Pioneering Crop Insurance Scheme**  
Minimum Premium, Maximum Insurance for Farmer Welfare  
**Pradhan Mantri Fasal Bima Yojana**

Farmers' contribution to premium reduced significantly.  
New scheme removes the previous capping on premium so that farmers get full sum insured.  
Use of simple & smart technology through phones & remote sensing for quick estimation and early settlement of claims.  
Multiple Localized risks and post harvest losses taken into account to ensure that no farmer is alone in times of distress.

**मंत्रिमंडल निर्णय**  
**राज्यात जलयुक्त शिवार 2.0 योजनेा प्रारंभ करण्यास मान्यता**

- 2014 ते 2019 या काळात प्रचंड यशस्वी झालेल्या राज्य सरकारच्या जलयुक्त शिवार योजनेचा दुसरा टप्पा दाबविण्यास मंत्रिमंडळाची मंजूरी
- पहिल्या टप्प्यात 5000 गावे निवडणार
- सामूहिक सिंचन सुविधांची विशेष तद्द
- राज्यातील गावे पुन्हा जलसमृद्ध होणार.
- गाळमुक्त धरण-गाळयुक्त शिवार योजनेला सुद्धा 3 वर्षे मुदतवाढ
- जलयुक्त शिवार अभियान प्रथम टप्पा तसेच इतर पाणलोट क्षेत्रविकास कार्यक्रम न दाबविलेल्या व गाव निवडीच्या निकषानुसार पार ठरणाऱ्या गावांमध्ये नूद व जलसंधारणाची कामे करणार.
- जलयुक्त शिवार अभियान प्रथम टप्पा तसेच इतर पाणलोट क्षेत्रविकास कार्यक्रम दाबविलेल्या व गावांमध्ये पाण्याची गरज असेल व अडविण्यास अपघात शिल्लक असेल तेव्हा पाणलोट विकासाची कामे करणार
- जलसाक्षरतेद्वारे गावातील पाण्याची उपलब्धता व कार्यक्षम वापराचा प्रयत्न करणार

13 डिसेंबर 2022

**PMKSY**  
**PRADHAN MANTRI KRISHI SINCHAI YOJANA**

**31.03 lakh hectare**  
covered under Micro irrigation in PMKSY

- Convergence of investment in irrigation at the field level.
- Expand cultivable area under irrigation
- Improve On-farm water use efficiency to reduce wastage of water .
- Enhance the adoption of being precise in irrigation and other water saving technologies(more crop per drop).
- Enhance recharge of aquifers and introduce sustainable water conservation practice

A NATIONAL MISSION TO IMPROVE FARM PRODUCTIVITY AND ENSURE BETTER UTILIZATION OF THE RESOURCES IN THE COUNTRY.

Devendrafadnavis | @devendra\_fadnavis | DevendraGFadnavis | Devendra Fadnavis

/BJP4Assam | assam.bjp.org

Fig. 113. Government Policies



### 5.12.3 MOBILE APPLICATION

Given below are some images of a smartphone application which will help the villagers in tracking the mobile pods and their availability. The app will have a feature to send in a call for any particular type of pod from a nearby base village. Villagers will also have access to a calendar which will show the timetable of pods for the month of that particular village and other villages too. The app will also provide information on different businesses that the villagers own and will be able to get in contact with them. It will also feature a progress tracking service which will hold necessary information about all the villages that this project will undertake.

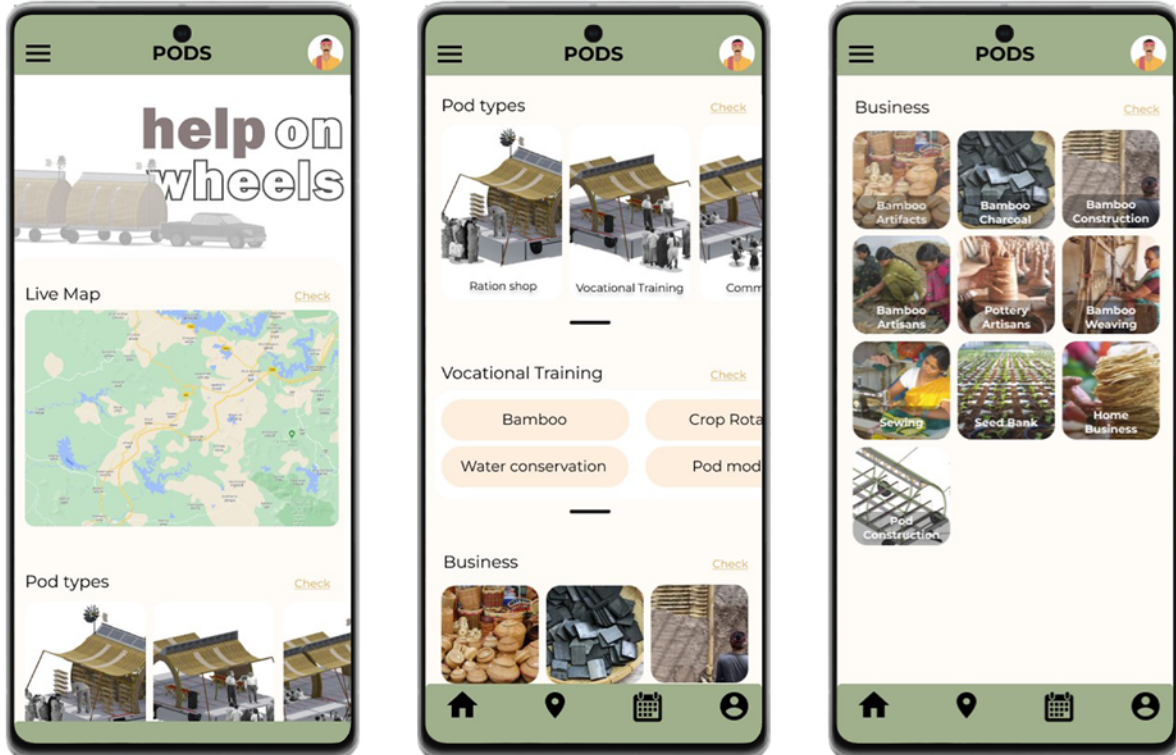

Fig. 114. SmartPhone Application to be used for Pod tracking, Businesses, and Vocational training courses

### 5.12.4 CONSTRUCTION MANUALS

Given below are the construction manuals which will be provided to the villagers so that they can build the Mobile Pods and the Community Resilience Shelter on their own. The manuals will contain all the information regarding basics of construction technology to the intricate details of joineries, equipments, skills required, and alternatives.

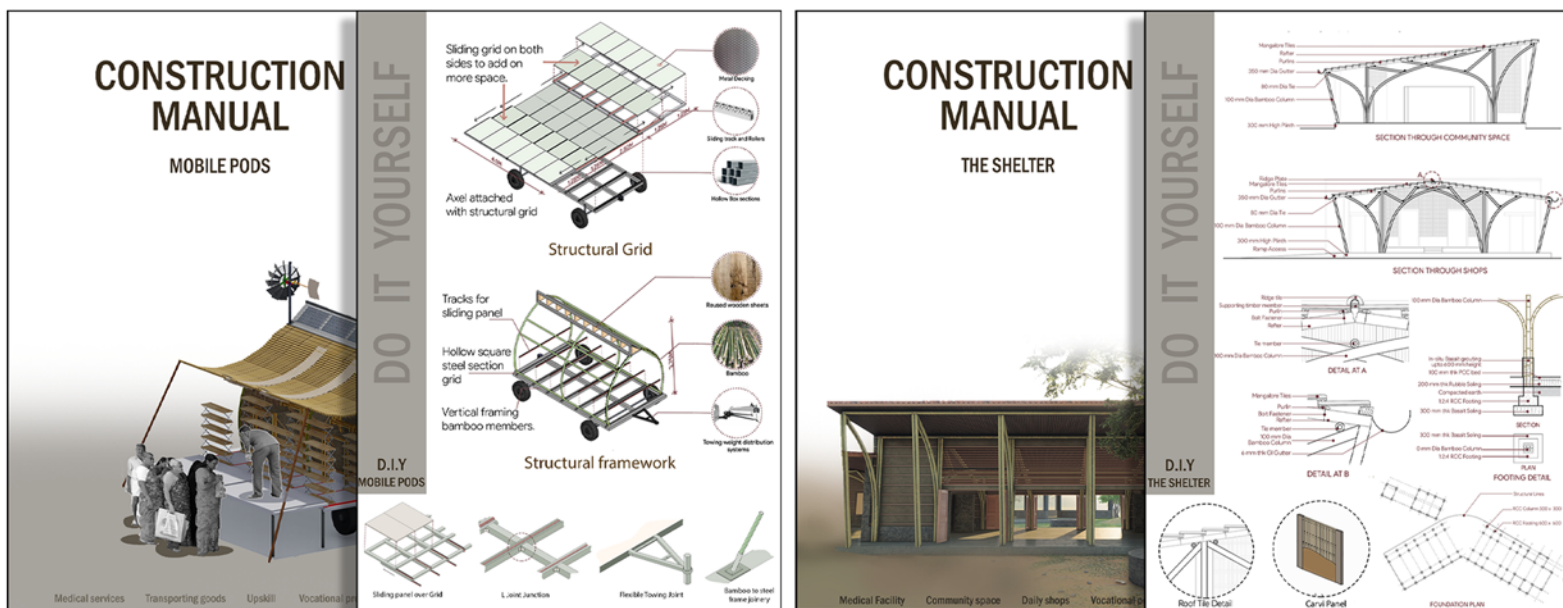

Fig. 115. Construction Manuals for Mobile Pods and Community Resilience Shelter



## 5.13 AFFORDABILITY

### MINIMIZING CONSTRUCTION COST

- 2 Existing structures that were present on site are reused and repurposed thus reducing construction cost and saving on materials
- Locally available materials like basalt and bamboo are used in order to reduce construction cost and thereby reducing the overall cost of the project
- To Minimize the use of Mechanical ventilation, strategies like cross ventilation, optimum opening sizes which allow fresh air inlet are provided.
- Louvers and bamboo slits have also been used to make spaces more breathable and allow good air flow in the space
- Maximum use of the available daylight has been done by providing larger openings on northern side for diffused light inlet.
- **Karvi panels:** Bamboo panels with wattle and daub have been used for walls. It is a low cost and low maintenance construction technique which makes it affordable and eco friendly.



Fig. 116. Plan



Fig. 117. Basalt Rock

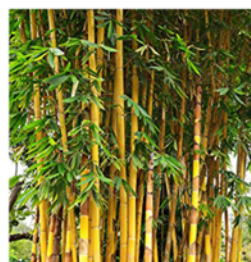

Fig. 118. Bamboo

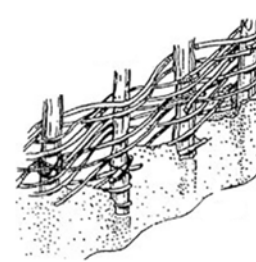

Fig. 119. Wattle and Daub

### 5.13.1 PROPOSED BAMBOO FARMING

A policy has been proposed by the project partner where bamboo farming will be given as a certain percentage of a farmland. This will include all people from the village who own a farm.

Bamboo takes 3 years to grow fully and be ready for harvest. This will be around the same time as the reservoirs begin to thrive and construction of CRS can start.

Thus, a sustainable bamboo farming will be made and that same bamboo will be used for construction of CRS which will effectively bring the material cost of bamboo to ZERO.



Fig. 120. Proposed Bamboo Farming

### 5.13.2 COST ESTIMATION

PROJECT SUMMARY					
Project Information					
Team:	Samakrut		Land Cost:	2.5	Million INR
Division:	Community resilience		City:	Veluk	
Site Area (sqm)	2,500		State:	Maharashtra	
Built-up Area (BUA) (sqm)	460				
Ground Coverage (Plinth Area) (sqm)	460				

S.No.	Particulars	Definition	Baseline Estimate (Project Partner / SOR basis)			Proposed Design Estimate		
			Amount (Million INR)	%	Amount (INR per sqm)	Amount (Million INR)	%	Amount (INR per sqm)
1	Land	Cost of land purchased or leased by the Project Partner	2.50	9.5%	5,435	2.50	15.6%	5,435
2	Civil Works	Refer Item A, Civil works in Cost of construction worksheet	1.68	6.4%	3,646	0.80	5.0%	1,731
3	Internal Works	Refer Item B, Civil works in Cost of construction worksheet	0.50	1.9%	1,078	0.07	0.5%	159
4	MEP Services	Refer Item C, Civil works in Cost of construction worksheet	0.36	1.4%	793	0.10	0.6%	218
5	Equipment & Furnishing	Refer Item D, Civil works in Cost of construction worksheet	0.00	0.0%	-	0.00	0.0%	-
6	Landscape & Site Development	Refer Item E, Civil works in Cost of construction worksheet	0.58	2.2%	1,251	0.55	3.4%	1,190
7	Contingency	miscellaneous expenses.	0.16	0.6%	338	0.09	0.5%	189
TOTAL HARD COST			5.8	22%	12,542	4.1	26%	8,921
8	Pre Operative Expenses	Cost of Permits, Licenses, Market research, Advertising etc	0.05	0.2%	117	0.05	0.2%	117
9	Consultants	Consultant fees on a typical Project	0.13	0.5%	274	0.13	0.5%	274
10	Interest During Construction	Interest paid on loans related to the project during construction	20.25	77.3%	44,031	11.72	44.7%	25,483
TOTAL SOFT COST			20.4	78%	44,422	11.9	45%	25,874
TOTAL PROJECT COST			26.2	100%	56,964	16.0	100%	34,795
TOTAL PROJECT COST (With out Interest during Construction)			5.95	0.23	12,933.02	4.28	0.26	9,312.21

S.No.	Particulars	Definition	Quantity	Rate (Rs)	Amount (Million INR)
1	New construction	This will involve the construction of Community Resilience Shelter along with all the services and land costs.			4.3
2	Renovation	Existing building in CRS will need renovation for repurpose			1.76
3	Mobile Pod	8 mobile pod to cater villages around the veluk	8	0.276	2.1
4	Devrai Plantation	17.6 acre of plantation around the reservoir and stepwells	17.6	120000	2.1
5	Stepwell	10 stepwells for domestic chores, seepage of water and	10	250000	2.5
6	Water Harvesting	includes reservoir and check dams to cater to the water			6.8
TOTAL PROJECT COST					19.6

Table 13. Cost Estimation



### 5.13.3 FUNDING OF THE PROJECT

Funding of the project is planned through Corporate Social Responsibility (CSR) and collaboration with a variety of NGOs which will provide funding for different parts of the project depending on the area of their expertise, no loans will be taken up and therefore there will be no interest costs will be beared upon the project partner, the village, or any other parties involved.

### 5.13.4 CSR AND COLLABORATION

#### RESERVOIR AND STEPWELL CONSTRUCTION

Construction of reservoir and the stepwells will be done by URVEE Public Trust in collaboration with PAANI foundation. PAANI foundation was set up by the core team of 'Satyamev Jayate' TV show. Their work is geared towards creating a people's movement to tackle generational crisis of drought in Maharashtra.

#### CONSTRUCTION OF COMMUNITY RESILIENCE SHELTER

This will involve the construction of Community Resilience Shelter along with all the services and land costs, and mobile pods.

- **Village rejuvenation and development:** This will be done in collaboration with TATA Motors CSR funds. TATA Motors CSR Initiative has been helping underdeveloped villages with rejuvenation and development process. URVEE Public Trust plans on collaborating with them for a major part of this project.

- **Material Technology and Execution:** COSTFORD is a voluntary organization which provides technological assistance for rural development.

- **Contracting and Execution:** This part of the project will be overlooked by URVEE Public Trust in collaboration with COSTFORD.

#### PLANTATION AND SEED BANKS

URVEE Public Trust will be collaborating with the following organisations for afforestation;

- **The Bamboo Nursery, Bhor:** This organisation was set up by Er. Vinay Kolte. They have been in close contact with URVEE Public Trust and will be collaborating for Bamboo Farming around the region.

- **Sahyardi Devrai:** This organisation was set up by Marathi Cinema Actor Sayaji Shinde; they currently have 29 Devrais, 2 Vruksha banks, Bio-diversity parks, Butterfly Gardens, and rock Gardens. They will be collaborating for Multi-Layered Vegetation planting around the reservoir.

- **14 Trees Foundation:** It is a charitable organization dedicated to building sustainable, carbon-footprint-neutral eco-systems through re-forestation.

S.No.	Particulars	Definition	Quantity	Rate (Rs)	Amount (Million INR)
1	New construction	This will involve the construction of Community Resilience Shelter along with all the services and land costs.			4.3
2	Renovation	Existing building in CRS will need renovation for repurpose			1.76
3	Mobile Pod	8 mobile pod to cater villages around the veluk	8	0.276	2.1
4	Devrai Plantation	17.6 acre of plantation around the reservoir and stepwells	17.6	120000	2.1
5	Stepwell	10 stepwells for domestic chores, seepage of water and	10	250000	2.5
6	Water Harvesting	includes reservoir and check dams to cater to the water			6.8
	<b>TOTAL PROJECT COST</b>				<b>19.6</b>

Table 14. Total Project Cost



## 6.0 APPENDIX

### 6.1 DETAILED AREA STATEMENT

\* Spaces with asterisk mark are repurposed RCC structures and **will not be added** in the built up area

MICRO PLANNING					
SR. NO.	SPACE	DESCRIPTION	AREA (SQ.M.)	NO.	TOTAL AREA
<b>SHELTER A</b>					
<b>Training and Economic Hub of CRS</b>					
	Administrative Space* (with toilets and record room)	Existing RCC structure repurposed Toilets of 4.5 sq.m. area Record room 9 sq.m. area	72	1	72
	Shops (with storage)	Retail front for mobile supply chain	15	4	60
	Multipurpose Space	Community Center/ Workshops/ Training Space	125	1	125
	Congregation Space	Gathering Space for all seasons, festivities and cultural activities	60	1	60
<b>SHELTER B</b>					
<b>Medical Facility*</b>					
	Waiting Area*	Existing RCC structure retrofitted with equipments, partitions, and 4 beds to function as a medical facility	Designated	1	
	Out patient Department*		10	1	10
	General Ward*		30	1	30
	Medical Shop*		8	1	8
<b>SHELTER C</b>					
<b>Bamboo Treatment Plant</b>					
	Loading/ Unloading Area	Outdoor space	35	1	35
	Stacking Space	Storage for to be treated bamboo	40	1	40
	Preparation Space	Space for preparing bamboo and borax for treatment	40	1	40
	Treatment Pools	2 pools of dimensions 6X1.5X1 M	75	1	75
	Air Drying Area	Outdoor semi open space	25	1	25
<b>TOTAL BUILT UP AREA OF CRS =</b>					<b>460</b>
<b>MOBILE NETWORK PODS</b>					
<b>Bamboo Treatment Plant</b>					
	Medical Facility Pod	Pods of size 2.5mX4.5m towed with available vehicles throughout the village network		3	
	Vocational Pod			1	
	Ration Shop Pod			1	
	Library Pod			1	
	Community Engagement Pod			1	
	Tourism Pod			1	
<b>MACRO PLANNING</b>					
SR. NO.	SPACE	AREA (SQ.M.)	NO.		TOTAL AREA (SQ.M.)
1	Water reservoir (avg depth: 6m)	-	1		
	Total Storage (45,884,475 L/year)	-			
2	Stepwell	300	10		3000
3	Water Purification System (3 Stage Reed Bed System)	North West of village			
4	Bamboo Plantation	Green Valleys			
5	Septic Tank	60	1		60
6	Biogas Plant (optional)	-			
7	Overhead Water Tank (1,51,267.5L)	72	1		72
8	Mulfi Layered Vegetation and Memory Forest	71224.67 (17.6 acres)	1		71224.67
9	Trenches, Pannam Keni, Qanats	-			
10	Greenhouse and Seed Bank	300.00	3		900

Table. 2. Area Statement

## 6.2 ARCHITECTURAL DRAWINGS





South Elevation

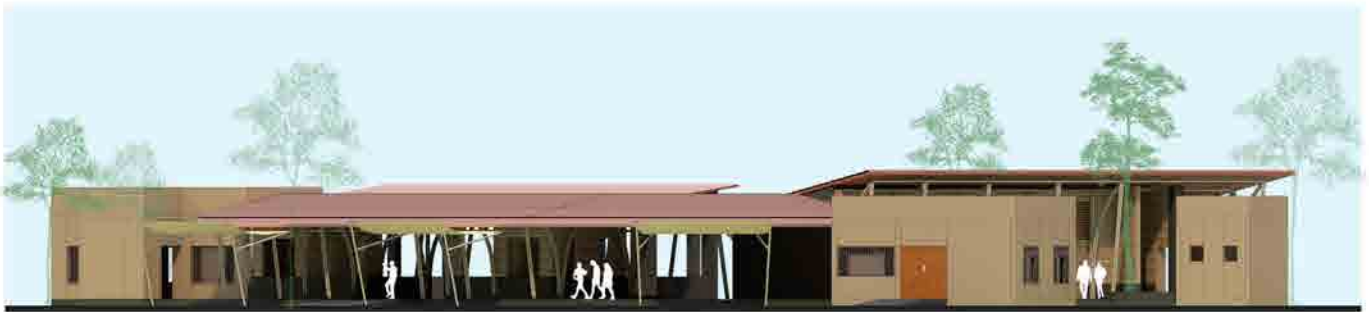

North Elevation



South West Elevation



North East Elevation



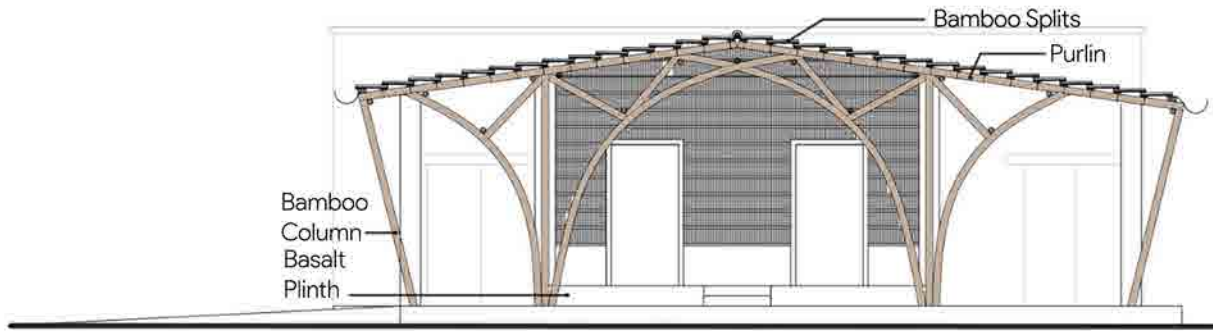

Section through shops showing design and structural system  
Plinth 1= |v| +0.3m, Plinth 2= |v| +0.6m, Basalt Parapet= |v| +1.2m, Wall height= |v| +4.4m

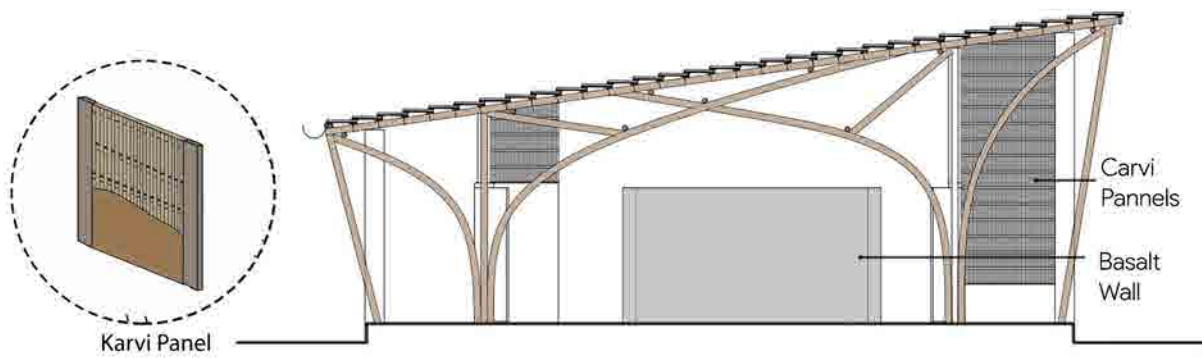

Section through training and workshop space  
Plinth 1= |v| +0.3m, Basalt Parapet= |v| +0.9m, Wall height (left)= |v| +3.3m, Wall Height (right)= 4.8m



### 6.3 ENGINEERING DRAWINGS

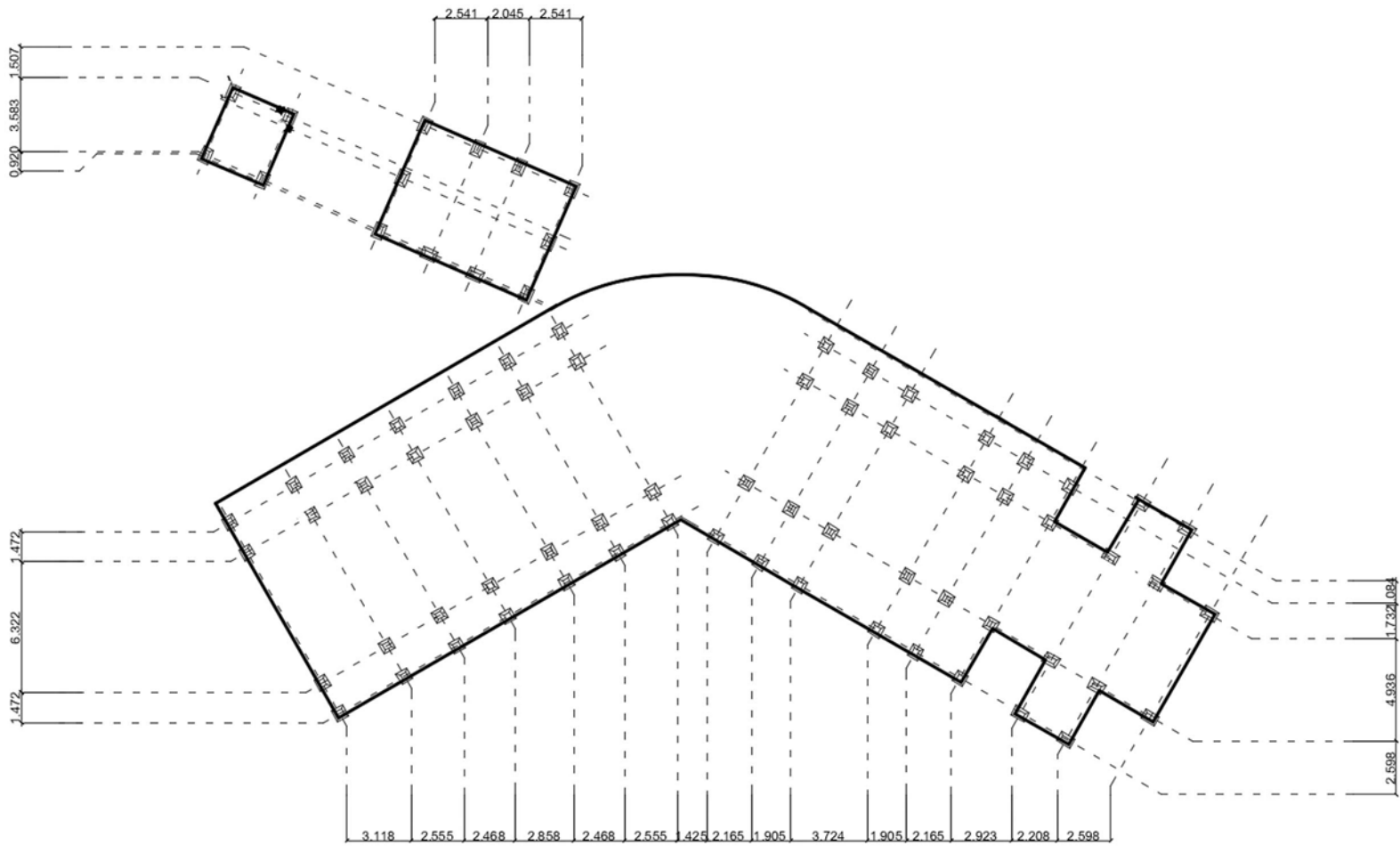

Foundation Plan

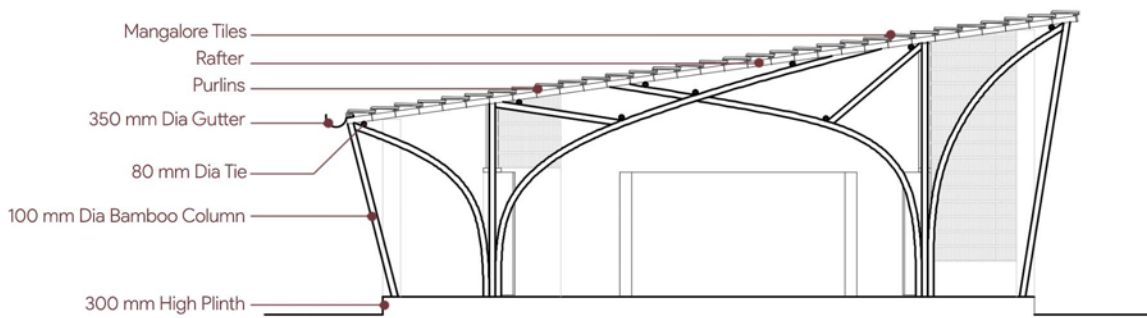

Section through community space

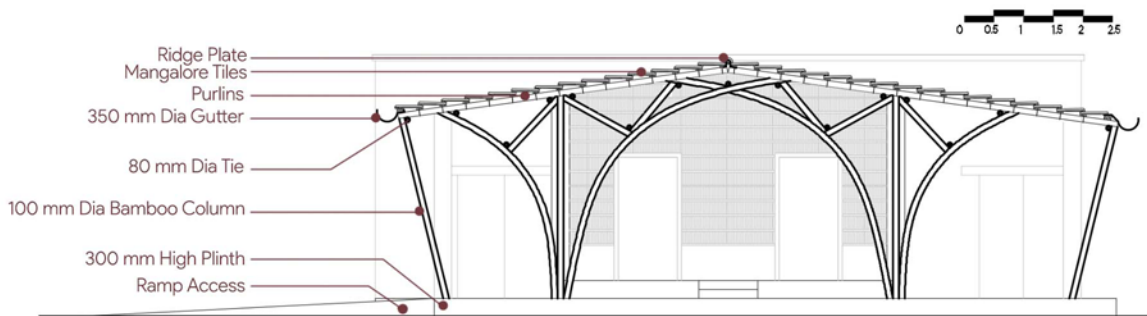

Section through shops





## 6.4 ENERGY SIMULATION INPUT AND OUTPUT PARAMETERS

Input Parameters	Units	Proposed Design Values
<b>General</b>		
<b>Building Area</b>	m <sup>2</sup>	460 sq.m.
<b>Conditioned Area</b>	m <sup>2</sup>	-
<b>Electricity Rate</b>	INR/kWh	6.09
<b>Natural Gas Rate</b>	INR/GJ	
<b>Building Occupancy Hours</b>	-	8 a.m. - 10 p.m.
<b>Average Occupant Density</b>	m <sup>2</sup> / person	100
<b>Internal Loads</b>		
<b>Interior Average Lighting Power Density</b>	W/m <sup>2</sup>	5
<b>List of Lighting Controls</b>	-	Basic Lighting Controls
<b>Average Equipment Power Density</b>	W/m <sup>2</sup>	12
<b>Minimum OA Ventilation (Building Average)</b>	l/sec.m <sup>2</sup>	0.02
<b>Envelope</b>		
<b>Roof Assembly U value</b>	W/m <sup>2</sup> .K	0.35
<b>Roof Assembly SRI</b>		0.3
<b>Average Wall Assembly U value</b>	W/m <sup>2</sup> .K	0.265
<b>Window to Wall Area Ratio (WWR)</b>	%	19.725
<b>Windows U value</b>	W/m <sup>2</sup> .K	1.4
<b>Windows SHGC</b>		-
<b>Windows VLT</b>	%	-
<b>Infiltration Rate</b>	ac/h	-
<b>Describe Exterior Shading Devices</b>		3m Overhangs at periphery
<b>HVAC System</b>		
<b>HVAC System Type and Description</b>	-	-
<b>Describe Mixed mode strategy in operation/controls of AC and windows</b>	-	-
<b>Heating Source</b>	-	-
<b>Heating Capacity</b>	kW	-
<b>Heating COP</b>		-
<b>Cooling Source</b>	-	-
<b>Cooling Capacity</b>	kW	-
<b>Cooling COP</b>		-
<b>Operation Hours</b>		-
<b>Heating Set Point</b>	°C	-
<b>Cooling Set Point</b>	°C	-
<b>Relative Humidity Setpoint</b>		-



Service Hot Water		
SHW Type and Description	-	-

Output Parameters	Units	Proposed Design Values	
Proposed EUI (Total)	kWh/m <sup>2</sup> / yr	20.61	
<b>EUI Breakdown by End Use</b>			
Heating	kWh/m <sup>2</sup> / yr	-	
Cooling	kWh/m <sup>2</sup> / yr	-	
Fans	kWh/m <sup>2</sup> / yr	-	
Pumps	kWh/m <sup>2</sup> / yr	-	
Heat Rejection	kWh/m <sup>2</sup> / yr	-	
Service Hot Water	kWh/m <sup>2</sup> / yr	-	
Lighting	kWh/m <sup>2</sup> / yr	13.18	
Equipment	kWh/m <sup>2</sup> / yr	7.51	
Total Envelope Heat Gain (Peak)	W/m <sup>2</sup>	-	
Cooling Load of Conditioned Area	SF/ Tr	-	
Building Electric (Peak)	W/m <sup>2</sup>	-	
Annual Operating Energy Cost	INR/m <sup>2</sup>	-	
Annual Unmet Hours	-	0	
Cooling Capacity	Tr	-	
Annual Hours of Comfort without Air Conditioning		5160	
Monthly Energy Performance		<b>Generation</b>	<b>Consumption</b>
Jan	kWh	27	97.7
Feb	kWh	25	97.7
Mar	kWh	28	108.8
Apr	kWh	29	104.7
May	kWh	30	108.2
Jun	kWh	15	104.7
Jul	kWh	8	108.8
Aug	kWh	9	97.7
Sep	kWh	16	87.7
Oct	kWh	24	87.7
Nov	kWh	25	97.7
Dec	kWh	25	97.7



## 6.5 NET ZERO WATER CYCLE DESIGN

The water cycle is divided into two: Macro water cycle and micro water cycle. Macro water cycle caters to all the water need of the village, farms, as well as economic use; whereas, micro water cycle caters to reuse of water in specific sectors namely, human consumption, farming irrigation, and bamboo curing.

### WATER REQUIREMENTS

#### Water calculations for village

No. of people in village = 747  
 Water requirement per person per day = 135 L/day  
 Total water requirement per day =  $747 \times 135 \text{ L} = 100,845 \text{ L/day}$   
 Annual water requirement =  $100,845 \text{ L} \times 365 = 36,808,425 \text{ L}$

Annual water storage requirement for village = 36,808,425 L  
 Consider 3 months of extra water storage  
 =  $36,808,425 + 9,076,050$   
 = **45,884,475 L/year**

#### Water calculation for CRS

Population capacity of CRS = 230  
 No. of people using CRS daily = 70  
 Water requirement =  $70 \times 135 = 9450 \text{ L}$   
 With a factor of safety of 1.2  
 Total water storage capacity required =  $1.2 \times 9450 = 11,340 \text{ L}$   
 Annual water requirement of CRS =  $11,340 \times 365 = 4,139,100 \text{ L}$

### WATER PROCUREMENT

#### Water calculation for Stepwells

Water holding capacity of one stepwell = 200,000 L  
 No. of stepwells used provided = 10  
 Total water stored in stepwells =  $10 \times 200,000 = 2,000,000 \text{ L}$

#### Rainwater Harvesting Tank Capacity

= mean annual rainfall (mm) x area(sq.m) x runoff factor  
 =  $1439 \times 2529.5$   
 Roof area = 2529.5m<sup>2</sup>, Land = 945m<sup>2</sup>  
 Run off factor  
 Roof = 0.9 Land = 0.3

Harvestable rainwater = mean annual rainfall (mm) x area(sq.m) x runoff factor  
 =  $1439 \times ((2529.5 \times 0.9) + (945 \times 0.3))$   
 = **36,83,911.95L**

#### Water calculation for reservoir

The proposed reservoir will hold around 50,000,000 L of water. The current area of the reservoir shown will be expanded upon to procure the required amount of water.

#### Total volume of harvestable rainwater = 3700 cu.m

Almost 50% rainwater should be reused and remaining water is allowed to seep into the soil to recharge underground water table. 1850  
 Dimension of tank: **Height = 5 m Radius = 11 m**

### WATER RECYCLING

#### Water requirement of the Village

Population of village = 747  
 Daily water consumption = 45L/person  
 Total Daily water consumption =  $747 \times 45 = 33,615 \text{ L}$

Amount of **Blackwater generated** =  $747 \times 20 = 14,940 \text{ L}$

This Blackwater is sent to Septic Tank through drainage lines.

Amount of **Greywater generated** =  $70 \times 25 = 18,675 \text{ L}$

This Greywater is sent to 3 stage reed bed system located near septic tank and is then reused in washrooms.

#### Water requirement of Community Resilience Shelter

Population capacity of CRS = 230  
 No. of people using CRS daily = 70  
 Daily water consumption = 45L/person  
 Total Daily water consumption =  $70 \times 45 = 3150 \text{ L}$

Amount of **Blackwater generated** =  $70 \times 20 = 1400 \text{ L}$

This Blackwater is sent to Septic Tank through drainage lines.

Amount of **Greywater generated** =  $70 \times 25 = 1750 \text{ L}$

This Greywater is sent to 3 stage reed bed system located near septic tank and is then reused in washrooms.

Dual Plumbing Systems will be used to separate blackwater and greywater.

Note: Plumbing system may seem to show only blackwater lines as the dual plumbing lines are laid one above another, but actually signify both blackwater and greywater. These will then change course just before the blackwater line enters into the septic tank.



## 6.6 SUMMARY OF COST ESTIMATION

Project Summary									
Project Information									
Team:		Samakrut		Land Cost:		2.5 Million INR			
Division:		Community resilience		City:		Veluk			
		Site Area (sqm)		460		State:		Maharashtra	
		Built-up Area (BUA) (sqm)		460					
		Ground Coverage (Plinth Area) (sqm)		460					

S.No.	Particulars	Definition	Baseline Estimate (Project Partner / SOR basis)			Proposed Design Estimate		
			Amount (Million INR)	%	Amount (INR per sqm)	Amount (Million INR)	%	Amount (INR per sqm)
1	Land	Cost of land purchased or leased by the Project Partner	2.50	9.5%	5,435	2.50	15.6%	5,435
2	Civil Works	Refer Item A, Civil works in Cost of construction worksheet	1.68	6.4%	3,646	0.80	5.0%	1,731
3	Internal Works	Refer Item B, Civil works in Cost of construction worksheet	0.50	1.9%	1,078	0.07	0.5%	159
4	MEP Services	Refer Item C, Civil works in Cost of construction worksheet	0.36	1.4%	793	0.10	0.6%	218
5	Equipment & Furnishing	Refer Item D, Civil works in Cost of construction worksheet	0.00	0.0%	-	0.00	0.0%	-
6	Landscape & Site Development	Refer Item E, Civil works in Cost of construction worksheet	0.58	2.2%	1,251	0.55	3.4%	1,190
7	Contingency	miscellaneous expenses.	0.16	0.6%	338	0.09	0.5%	189
<b>TOTAL HARD COST</b>			<b>5.8</b>	<b>22%</b>	<b>12,542</b>	<b>4.1</b>	<b>26%</b>	<b>8,921</b>
8	Pre Operative Expenses	Cost of Permits, Licenses, Market research, Advertising etc	0.05	0.2%	117	0.05	0.2%	117
9	Consultants	Consultant fees on a typical Project	0.13	0.5%	274	0.13	0.5%	274
10	Interest During Construction	Interest paid on loans related to the project during construction	20.25	77.3%	44,031	11.72	44.7%	25,483
<b>TOTAL SOFT COST</b>			<b>20.4</b>	<b>78%</b>	<b>44,422</b>	<b>11.9</b>	<b>45%</b>	<b>25,874</b>
<b>TOTAL PROJECT COST</b>			<b>26.2</b>	<b>100%</b>	<b>56,964</b>	<b>16.0</b>	<b>100%</b>	<b>34,795</b>
<b>TOTAL PROJECT COST ( With out Interest during Construction)</b>			<b>5.95</b>	<b>0.23</b>	<b>12,933.02</b>	<b>4.28</b>	<b>0.26</b>	<b>9,312.21</b>

Fig. 51. Cost Estimation Summary of Community Resilience Shelter Only

S.No.	Particulars	Definition	Quantity	Rate (Rs)	Amount (Million INR)
1	New construction	This will involve the construction of Community Resilience Shelter along with all the services and land costs.			4.3
2	Renovation	Existing building in CRS will need renovation for repurpose			1.76
3	Mobile Pods	8 mobile pods to cater villages around the veluk	8	0.276	2.1
4	Multi Layered Plantation and Memory Forest	17.6 acre of plantation around the reservoir and stepwells	17.6	120000	2.1
5	Stepwell	storsge.	10	250000	2.5
6	Water Harvesting	Includes reservoir and check dams to cater to the water needs.			6.8
<b>TOTAL PROJECT COST</b>					<b>19.6</b>

Fig. 51. Break up of Cost Estimation of the WHOLE PROJECT

NEW SHEETS HAVE BEEN ADDED IN THE EXCEL WORKBOOK TO PROVIDE FURTHER BREAKUP OF THE COST ESTIMATION OF ELEMENTS SHOWN ABOVE. ALSO A NEW SUMMARY TABLE (BOTTOM) HAS BEEN ADDED.

THE PROJECT WILL BE FUNDED USING CSR (CORPORATE SOCIAL RESPONSIBILITY) FUNDS AND THEREFORE NO LOAN CALCULATIONS WILL BE APPLICABLE THEREBY EFFECTIVELY DRIVING FINANCIAL COSTS TO ZERO.

KINDLY REFER TO THE TABLE AT THE BOTTOM AND NEWLY ADDED SHEETS TO THE WORKBOOK FOR ACTUAL COST ESTIMATE OF THE PROJECT (ESTIMATION INCLUDES ALL 3 ASPECTS OF THE PROJECT).

## 6.7 SUMMARY OF EMBODIED CARBON

THE EMBODIED CARBON CALCULATIONS AND ANALYSIS HAS BEEN DONE IN DESIGN BUILDER. GIVEN CARBON TOOL COULD NOT BE USED DUE TO LACK OF GWP INFORMATION ON REQUIRED MATERIALS EVEN AFTER LOOKING THROUGH NUMEROUS RESEARCH PAPERS.

GIVEN BELOW ARE SCREENSHOTS FROM DESIGN BUILDER SIMULATIONS SHOWING BASE CASE (LEFT) AND PROPOSED CASE (RIGHT).

THESE FIGURES WILL BE FURTHER OFFSETED DUE TO REUSE OF EXISTING STRUCTURES AND CREATION OF CARBON SINKS AROUND THE STRUCTURE IN THE NEAR FUTURE

Constructions Embodied Carbon and Inventory	Area (m2)	Embodied Carbon (kgCO2)	Equivalent CO2 (kgCO2)
ROOF	428.0	119340.7	119631.8
External floor - Energy code standard - Medium weight	170.4	1326.6	1378.1
115mm single leaf brick (plastered both sides)	75.5	3991.6	4178.4
Wooden door	14.7	0.0	0.0
WALL WATTLE N DAUB	331.6	12799.6	12996.2
Roof Attic & Other Steel Joists R-35 (6.2) U-0.037 (0.21)	122.0	0.0	0.0
Ground floor slab - Energy code standard - Medium weight	373.1	10083.4	12708.4
Sub Total	1515.2	147541.93	150892.85

Glazing Embodied Carbon and Inventory	Area (m2)	Embodied Carbon (kgCO2)	Equivalent CO2 (kgCO2)
Sgl Clr 6mm	211.8	3812.8	3812.8
Local shading		0.0	0.0
Window shading		0.0	0.0
Sub Total	211.8	3812.8	3812.8

<b>Building Total</b>	<b>1727.1</b>	<b>151354.7</b>	<b>154705.6</b>
-----------------------	---------------	-----------------	-----------------

Constructions Embodied Carbon and Inventory	Area (m2)	Embodied Carbon (kgCO2)	Equivalent CO2 (kgCO2)
Clay tiles (25mm) on air gap (20mm) on roofing felt (5mm)	428.0	11815.9	12243.9
External floor - Energy code standard - Medium weight	170.4	1326.6	1378.1
Lightweight 2 x 25mm gypsum plasterboard with 100mm cavity	75.5	407.5	441.5
Wooden door	52.8	0.0	0.0
Brick/block wall (insulated to 1995 regs)	333.7	20775.9	27624.8
Flat roof U-value = 0.25 W/m2K	122.0	1985.7	5484.4
Ground floor slab - Energy code standard - Medium weight	373.1	10083.4	12708.4
Sub Total	1555.5	46395.04	59881.06

Glazing Embodied Carbon and Inventory	Area (m2)	Embodied Carbon (kgCO2)	Equivalent CO2 (kgCO2)
Sgl Clr 6mm	171.6	3088.9	3088.9
Local shading		0.0	0.0
Window shading		0.0	0.0
Sub Total	171.6	3088.9	3088.9

<b>Building Total</b>	<b>1727.1</b>	<b>49483.9</b>	<b>62969.9</b>
-----------------------	---------------	----------------	----------------



## 6.8 GOALS

### 6.8.1 PRIMARY GOALS

#### Water Performance

##### Aim

To achieve 60% Water savings. Provide 30,757,725 L of water reservoir for human consumption. Irrigation and economic use calculations will be done later.

##### Strategies

Followin are the strategies applied to achieve the aim: Water efficient plumbing fixtures, dual plumbing system, water metering, drip irrigation using bamboo shoots, bioswales, terraced trenches, surangam (catchment sumps), Panam Keni, Zabo, crop rotation, vegetative filter strips, rainwater harvesting.



Fig. 11. Process of water metering

#### Resilience

##### Aim

Designing climate resilient structure. Creating job employment for at least 350 people (70% of the total population).

##### Strategies

Resilient structure to withstand drought and natural calamities, adapt the changes in climate and maintain thermal comfort. Function, cluster planning.

Resilience in terms of people will be buit up by setting up bamboo curing plant, cottage industries for women like weaving clothes and mats, health and hygiene, nursing, vocational.



#### Energy Performance

##### Aim

To achieve target EPI of 55 with energy savings of 50%.

##### Strategies

This aim will be achieved by integration of passive design strategies (mutual shading, thermal mass, natural ventilation, daylight (diffused), reduce heat gain (thermal mass), solar panels, peloton wheel energy generation, building orientation, fenestration design, lighting, plug loads, cooling loads.



#### Architectural Design

##### Strategies

Modular design, community gathering spaces, cultural hub, thermally comfortable environment, spatial planning according to orientation, vegetative shading, cluster planning, and daylight potential to achieve a minimum of 90% of the area throughout the year.

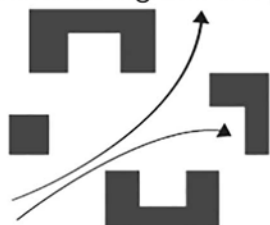

Fig. 12. Cross ventilaiton

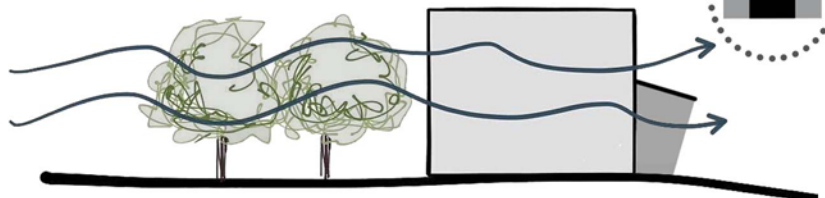

Fig. 13. Evaporative cooling

#### Affordability

##### Aim

Cradle-to-cradle system of material design.

##### Strategies

Local materials ( bamboo, wood), construction cost reduced, less maintenance cost, modular design repetition, flexibility for the replicable module over a large scale. Material specifications, modular construction, labour cost (local labour), self-sustainable,



## 6.8.2 SECONDARY GOALS

### Innovation

#### Aim

To innovate on-site water generation sector to offset the water demand.

#### Strategies

Peloton wheel, water filtration, water collection system (an amalgamation of traditional methods and local material), water filtration through canals (macro and micro level).

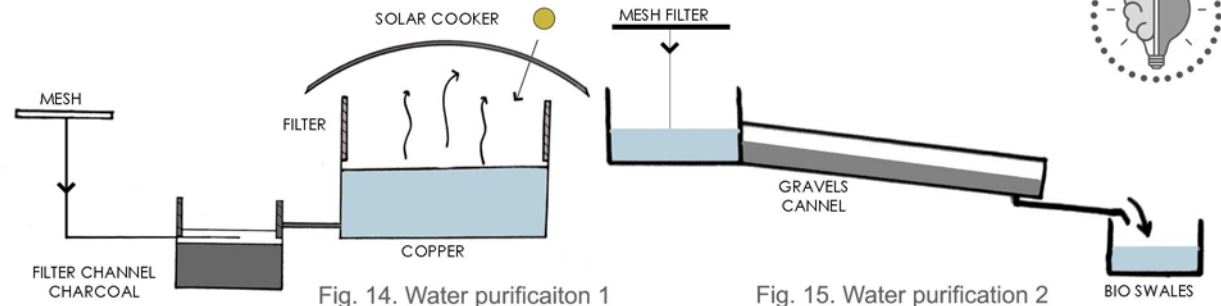

### Value proposition

#### Aim

Phase-wise design to cater to user needs over time.

#### Strategies

Modular design, flexible modules, expandable design as a future provision. Rejuvenation of village through employed design strategies.

### Health and well-being

#### Aim

Ensuring indoor environmental quality (air quality, visual, thermal & acoustical comfort). indoor air quality, natural paints.

#### Strategies

Mud is used as material, air purifying plants, and shaded pathways with climbers over bamboo shade. Indoor lighting of 300 - 400 LUX, indoor temperature range between 20 - 24 deg C, (Air Quality Index) AQI<50, no VOC materials, good ventilation (stack and cross), Humidity between 30% to 50%.



### Social Stability

Social stability of the village can be sustained by providing congregational spaces like a cultural hub, community gathering space, and employment generation for men and women in fields, construction, networking with different NGOs for educating people and setting up vocational upskill programs.



### 6.8.3 TERTIARY GOALS

#### Communication

**Aim**

To increase awareness about water conservation and gain a better understanding of efficient agriculture practices.



**Strategies**

Collaboration with NGOs, Learning and teaching seminars to tackle the current water and agricultural situation. Targeting NGOs that will help in the afforestation of the environment.

#### Engineering and Operations

**Aim**

Minimize material waste and energy consumption during construction & operation.



**Strategies**

Optimising the structural system definition and service function of modules through proper channels. Using construction techniques which will be energy efficient.

#### Embodied Carbon

**Aim**

Reducing embodied carbon as much as possible.



**Strategies**

Using local materials for construction. Cutting transportation costs. Innovations in material design and use to reduce cooling loads and efficiently reduce waste.

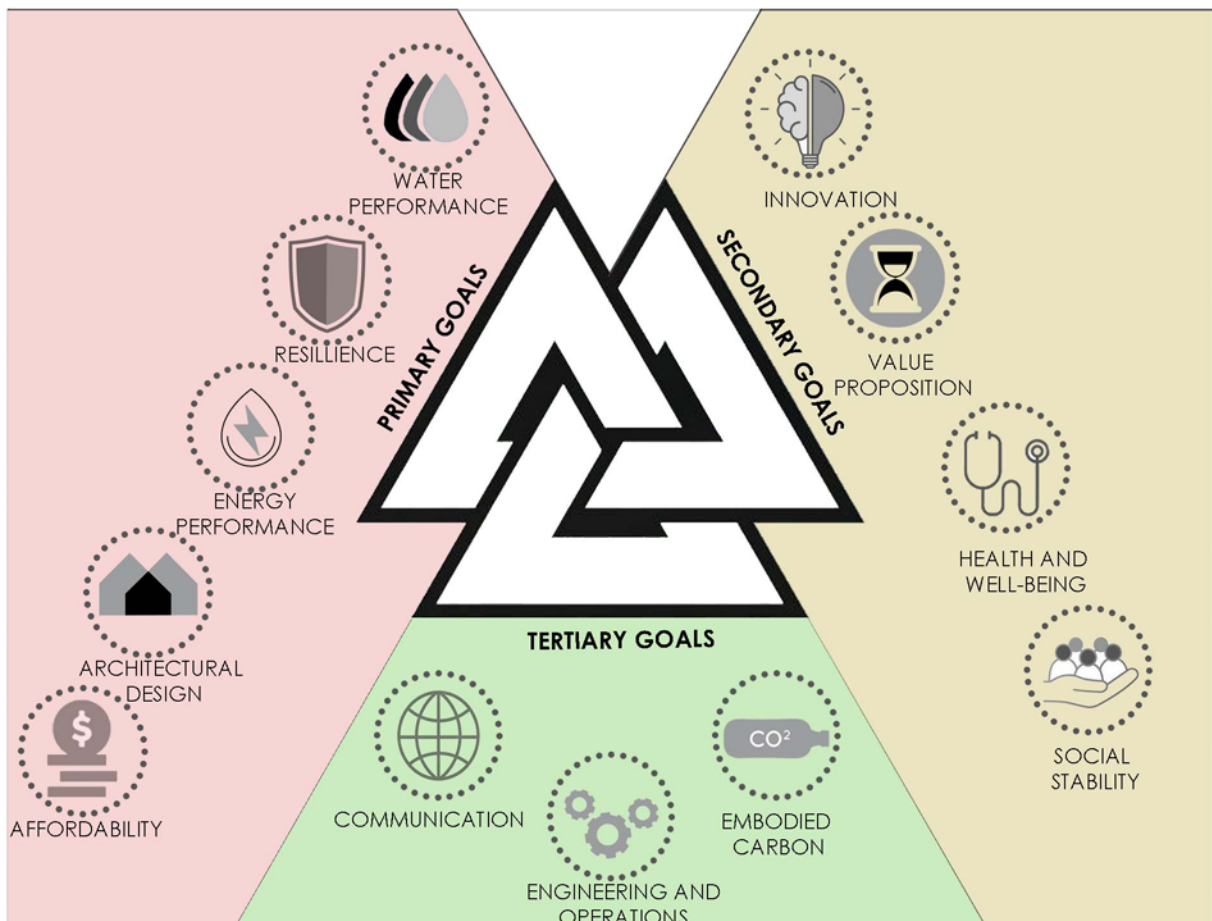

Fig. 16. Hierarchy of goals





### 6.9 WATER SUPPLY AND DRAINAGE LAYOUT

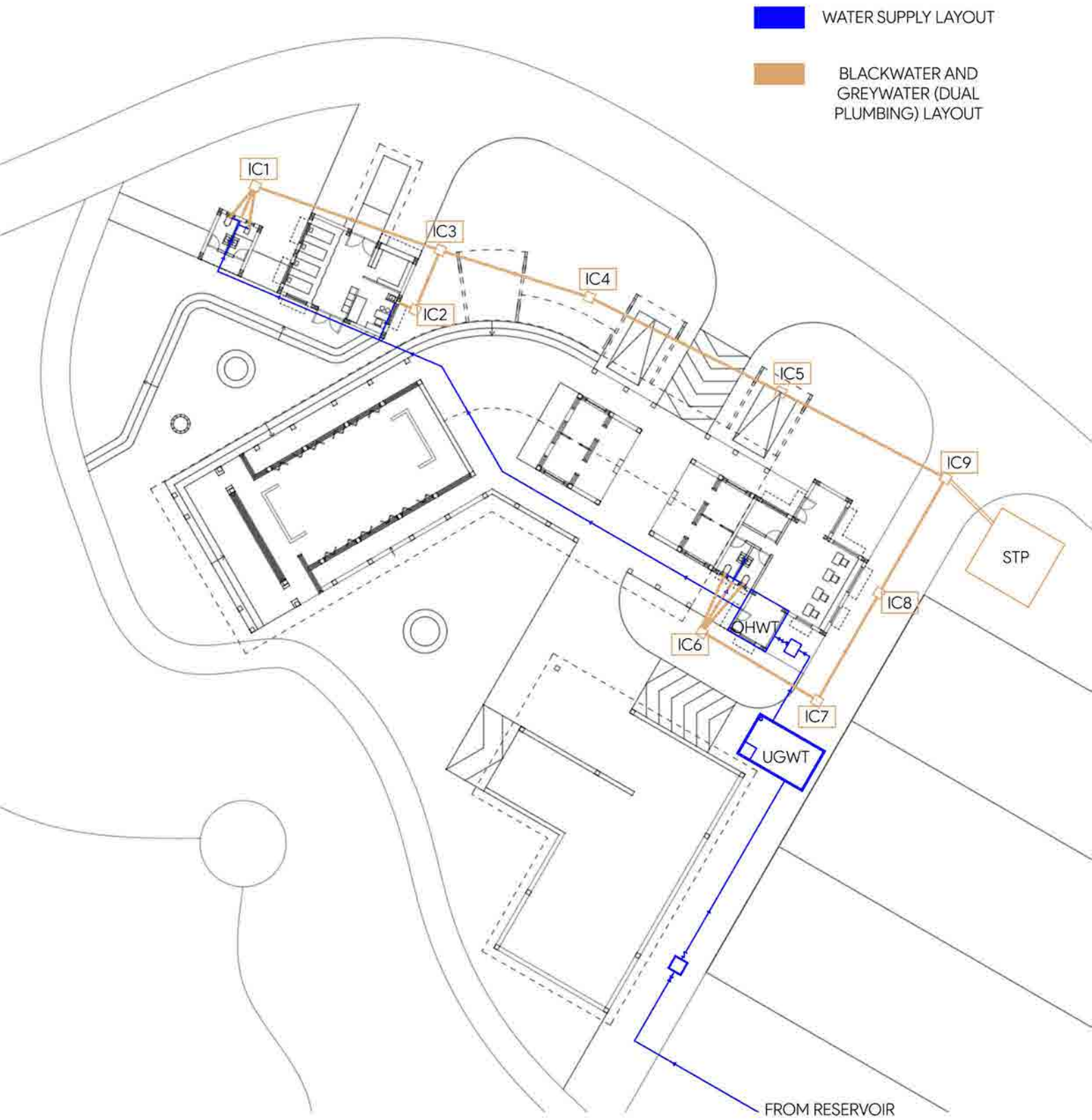

Fig. 23. Water Supply and Drainage Layout



## 6.10 ELECTRICAL LAYOUT

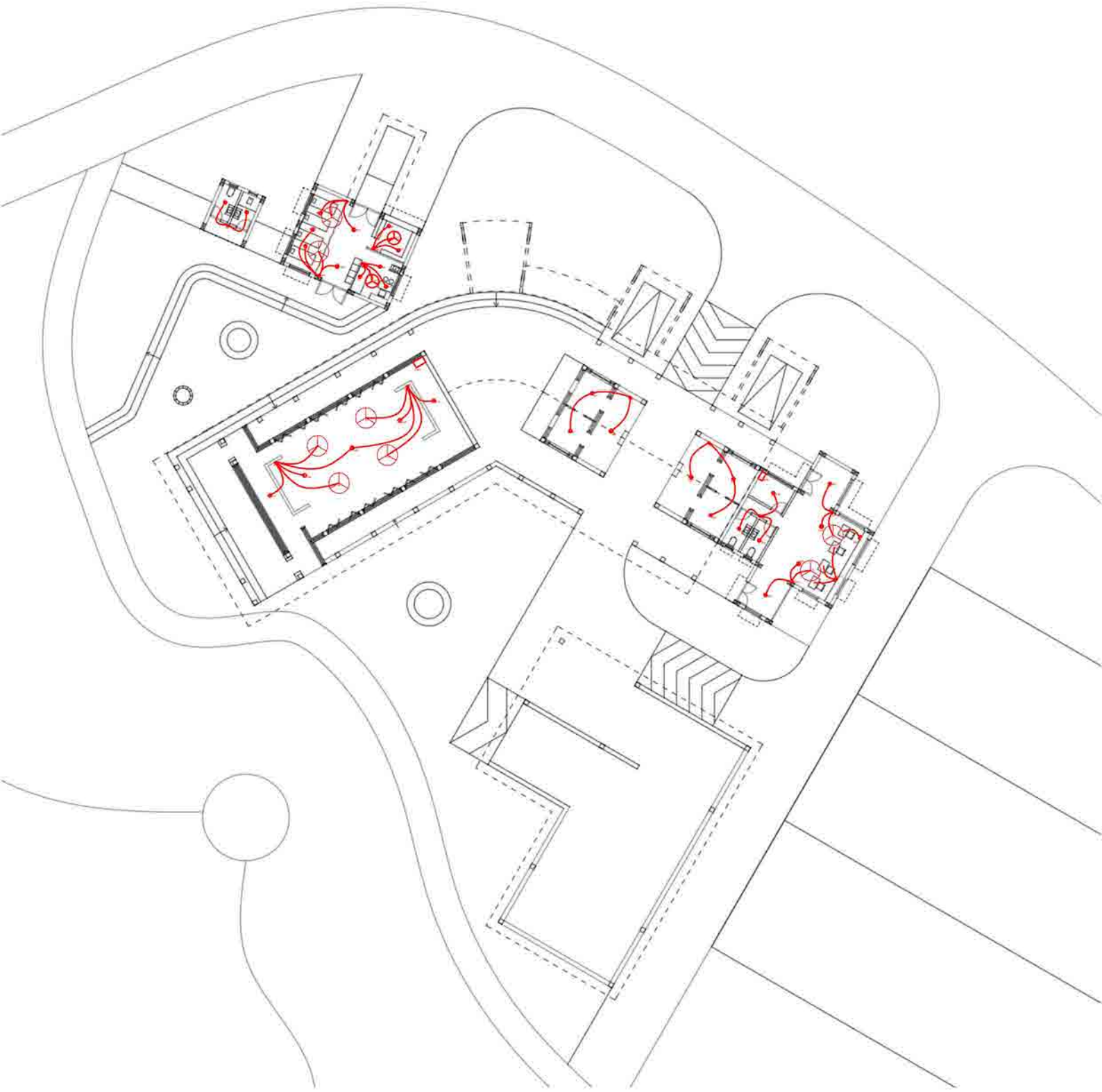
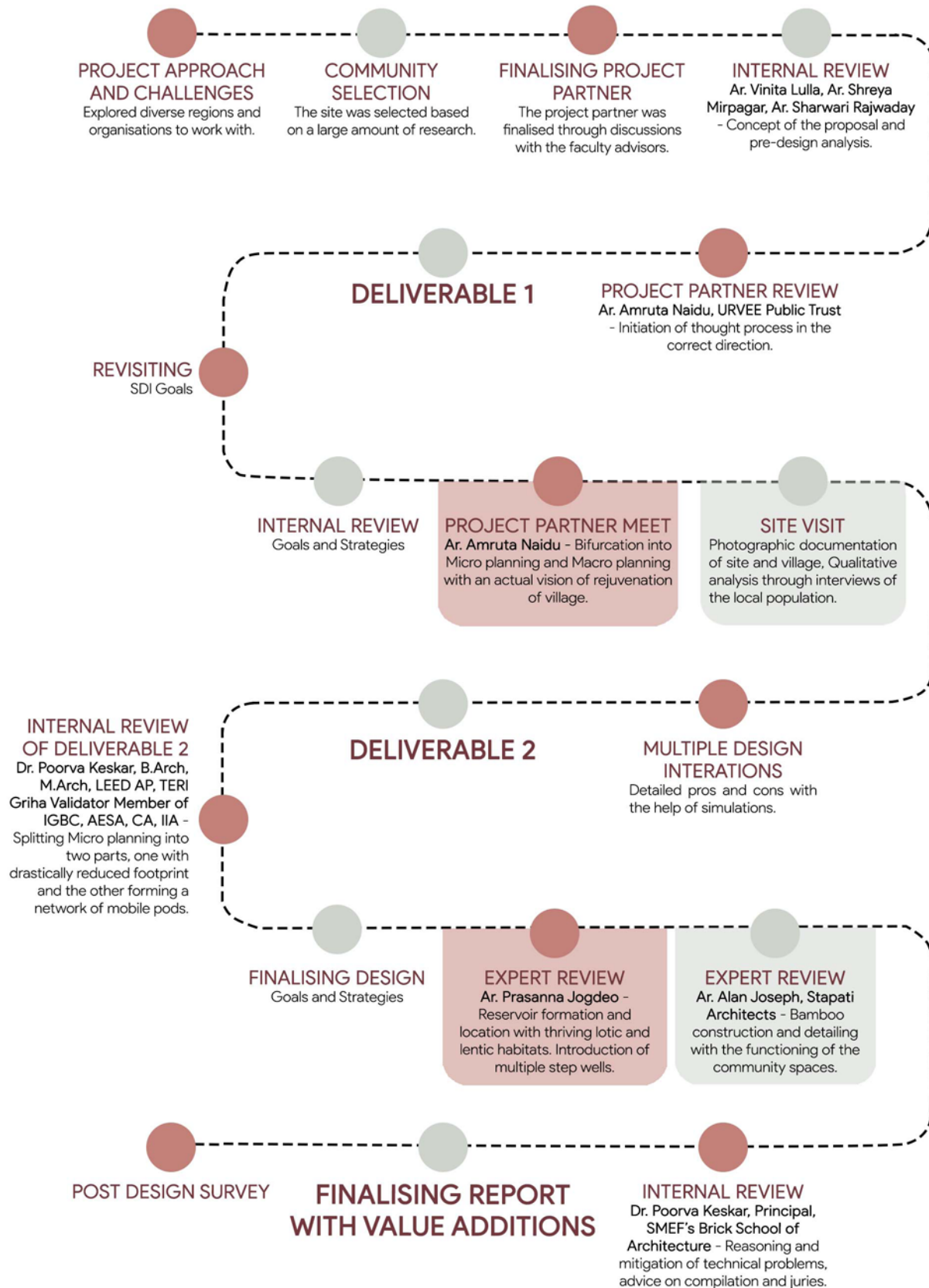

Fig. 23. Electrical Layout



## 6.11 DESIGN MANAGEMENT PROCESS



### 6.12 ACTIVITY MAPPING

